

Enjoy the Outdoors™

...with **Pilot Rock®**

PARK • STREET • CAMP SITE PRODUCTS

YOUR PREMIERE SOURCE FOR:

- Park Benches, Athletic Benches
- Picnic Tables
- Trash & Recycling Receptacles
- Bear Resistant Products
- Lantern Poles
- Utility Tables
- Custom Signs & Engraving
- Bicycle Racks
- Charcoal Grills
- Campfire Rings
- Custom Fabrication
- Much More!



Pilot Rock®

PARK • STREET • CAMP SITE PRODUCTS

RJ Thomas Mfg. Co.

Cherokee, Iowa • 800-762-5002

pilotrock@rjthomas.com • pilotrock.com

CATALOG #270

Park & Street Benches 4-27

Square Frame Bench - B130 Series.....	4
Recycled Plastic Bench - RBF & RBB Series.....	5
Channel Bench - CXB Series.....	6-7
Contemporary Bench - B120 Series.....	8
Accessible Bench - B110 & B111 Series.....	9
Classic Bench - CLB Series.....	9
Contour Benches - WRB & OWRB Series.....	10
Trailside Bench - WB & OWB Series.....	11
Amherst Bench - B100 & B102 Series.....	12
Wall Mount Bench - WMB Series.....	13
Park Avenue Bench - BC3001 & BC4001 Series.....	13
Grey Creek Bench - B30 Series.....	14
Silver Sioux Bench - B40 Series.....	15
Riverview Bench - B60 & B70 Series.....	16-17
Gillette Bench - B80 Series.....	18
Oak Knoll Bench - B90 Series.....	19
Athletic Benches - B300, AB & APB Series.....	20-21
Sign Benches - B400 & B410 Series.....	22-23
Signage & Accessories.....	24-25
Cover Caps, Armrests.....	26

Picnic Tables 28-51

Heavy Duty Table - UT Series.....	28
Extra Heavy Duty Table - XT Series.....	29
Accessible Tables - UT & XT Series.....	30
Kid's Table - UTK, SQTK, T104K Series.....	31
Universal Access Table - WXT & WXTH Series.....	32
Universal Access Table - WPTS Series.....	33
Custom Identity Table - T720 Series.....	33
A-Frame Table - AFT, WAT, AT Series.....	34-35
Caterpillar Table - T600 Series.....	36
Light Duty Table - BT Series.....	36
Recycled Plastic Table - RT, ART Series.....	37
Portable Square Table - SQT Series.....	38
Square Pedestal Table - PQT Series.....	39
Round Tables - T100, T200, T300, T400 Series.....	40-41
Multi-Pedestal Table - APT Series.....	42
Twin Pedestal Table - TPT Series.....	43
Single Pedestal Table - PT Series.....	43
Square Frame Picnic Table & Utility Table - T700 Series.....	44
Food Court Table - FCT Series.....	45
Snow Load/Extreme Load Table Ratings.....	46
Accessibility Compliance.....	47
Umbrellas.....	48
Accessories for Tables.....	49-50
Maintenance Tips for Picnic Tables & Benches.....	51

Materials & Color Options 52-57

Waste & Recycling 58-77

Bear Resistant Trash Receptacle - BPRT Series.....	58
Varmint Defiant Trash Can Cover - VDT Series.....	59
Park Policeman - CN-EXP Series.....	59
Round Receptacle - Vertical Steel Straps, Perforated Steel.....	60
Round Receptacle - Expanded Steel, Cut Steel Plate.....	61
Round Receptacles with Doors - Cut Steel Plate & Steel Strap.....	62
Amherst Receptacle - Round or Square.....	63
Round Receptacle - Vertical Wave Steel Strap.....	63
Trash & Recycling Receptacles - TRH Series.....	64
Tilting Trash Receptacle - CN-TR-52 Series.....	65
Kolorcans - Plastic Trash Receptacles.....	65
Square Receptacle - TRQ Series.....	66
Square Receptacle - Expanded Steel.....	66
Square Frame Receptacle - CN-Q-36.....	67
Square Receptacle with Door - CN-Q/SS4-36D.....	67
Trash & Recycling Receptacle Lids.....	68-71
Trash & Recycling Receptacle & Lid Accessories.....	72
Trash Cans, Liners.....	73
Stationary Mounts for Trash Receptacles.....	74
Smoker's Stack.....	74
Trash Can Hangers.....	75

Waste & Recycling Continued

Recycling Arrays - RA Series.....	76
Pet Waste Stations - Pilot Rock & Dogipot.....	77

Dog Park Products 78-79

Products for Dogs.....	78
Products for People.....	79

Site Amenities..... 80-87

Food Lockers - BPFL Series.....	80-81
Lantern Poles.....	82
Traffic Barriers, Car Stops & Speed Bumps.....	83
Utility Tables.....	84-85
Condiment Serving Table - CST Series.....	86
Marksman Shooting Table - MST-1 Series.....	86
Planters.....	87
Tissue Dispensers.....	87

Wayfinding Signs 88-89

Bike Racks 90-95

Safety Bike Rack.....	90
Omega Bike Rack.....	90
Bollard Bike Rack.....	91
Hoop Bike Rack.....	91
Vertical Bike Rack.....	92
Wheel Style Vertical Bike Rack.....	93
Steel Wheels Bike Rack.....	93
Hitching Post Bike Rack.....	94
Hitching Post Group Bike Rack.....	94
Saddleback Bike Rack.....	95

Charcoal Grills..... 96-111

Accessible Grill - ASW, ASWS Series.....	96-97
Premier Series Grills - A, B, C, & D Series.....	98-99
Multilevel Grills - N, Q, H, J, K Series.....	100-104
Covered Grill - EC Series.....	105
Large Group Grills - Q3, P, L Series.....	106-107
Grill Station & Swivel Shelf.....	108
Hot Coal Bin.....	109
Grill Accessories.....	110
Maintenance Tips for Charcoal Grills & Campfire Rings.....	111

Campfire Rings 112-125

Campfire Rings - FX Series.....	112
Campfire Rings - FA Series.....	113
Campfire Rings - FS Series.....	114
Campfire Rings - FSW Series.....	115
Multilevel Firering - L Series.....	116
Large Group Firering - O Series.....	116
Snow Load Rated Swivel Grate Firerings.....	117
ADA Campfire Ring Guidelines.....	117
Accessible Firerings - M, LDW, FSDW, FS, FSW Series.....	118-119
Stainless Steel Campfire Rings.....	120
Removable Cooking Grate.....	120
Spark Arrestors.....	121
Cooking Grates for Firerings.....	122
Campfire Ring Covers.....	123
Firering Lockout Covers.....	123
Clean Out Shovel.....	124
Utility Shelf.....	124
Heat Shields.....	124
Anchoring Systems for Firerings.....	125

Misc. Information..... 126-131

Anchor Kits & Anchor Systems.....	126-127
Ordering & Shipping Information.....	128
Product Warranty.....	129
Proposition 65 Warnings.....	129
RJ Thomas Custom Fabrication.....	130-131

TABLE OF CONTENTS



Check out these Online Features

- ✓ **Configure Your Product** Start with the Products tab, then select the product line you want. Select from various designs and choose the features you want to show the unit price in the Quote Cart.
- ✓ **Request a Quote** Add your item(s) to the Quote Cart. Then request a price and freight quotation. Or use the Quick Quote form.
- ✓ **Online Purchasing** After receiving our RFQ response you can place your order online.
- ✓ **Buy Now Ordering** The Buy Now section of our website lets you place orders immediately for select items without going through the RFQ process.
- ✓ **Product Spec Bulletins** Detailed product spec sheets are available for most products. Download from Spec Bulletins in the top navigation bar or on the product pages.
- ✓ **Online Catalog** Download our current catalog to view or save.
- ✓ **Online Price List** Download our current price list to view or save.
- ✓ **Register to Build your Profile** By registering you will be able to login when you visit our site and see your quotes and online orders history. This will also pre-fill forms on our site. It does not save credit card information.
- ✓ **Sign up for E-Newsletter** Receive information on Pilot Rock products and promotions.
- ✓ **Free Tools & Tips** See product videos, maintenance tips and other guidelines.

To Help Us Serve You More Quickly...

When contacting us by phone or e-mail to request product information or a price quote, please have the following product details ready:

TABLES AND BENCHES

- Model Series:** For example, XT Series picnic table or CXB Series bench.
- Preferred Frame Installation:** Portable, surface mount or embedded frame posts.
- Preferred Frame Finish:** Such as galvanized, or powder coated with color choice.
- Desired Length:** For example, 4 foot, 6 foot, 8 foot, 10 foot, 12 foot.
- Top/Seat/Back Material:** Such as lumber, recycled plastic or thermo-plastic coated steel.
- Wheelchair Accessible:** For example, end or side access on a table.

TRASH AND RECYCLING

- Model Series:** For example, TRH Series or Amherst Series.
- Desired Shape:** Such as round or square.
- Required Capacity:** Such as 32 gallon or 55 gallon.
- Preferred Material:** For example, lumber, recycled plastic or thermo-plastic coated steel.
- Lid Function:** Collecting trash or recyclables.
- Type of Lid:** Flat or domed, steel or plastic and which color.
- Choice of Mounts:** For receptacle - surface mount or permanent pedestal mount.

GRILLS AND FIRE RINGS

- Model Series:** Such as A-20 or FS-30.
- Size:** Square inches of cooking area desired or firering diameter.
- Cooking Grate Adjustment:** Infinitely Adjustable, multilevel or single level.
- Installation Method (grills):** Embedded post, bolt down base plate, disk base or caster base.
- Installation Method (firerings):** For example, tip back anchor pins or spade anchors.

With this information at hand, Customer Service can quickly provide you with a complete Model Number for reference and a price quote including all of the requested features. Please help us serve you better by having as much of this product information available when you contact us.



NEW PRODUCTS

Custom Identity Picnic Table	33
Umbrella Base	50
Marksman Shooting Table	86
Firering Spark Arrestor	121
Foldable Cooking Grate	122
Firering Lockout Cover	123



**Just Look For The
"NEW" Icon!**

OFFICE HOURS:

8 am to 5 pm CST, Monday - Friday
Closed weekends and holidays



SQUARE FRAME BENCH - B130 Series

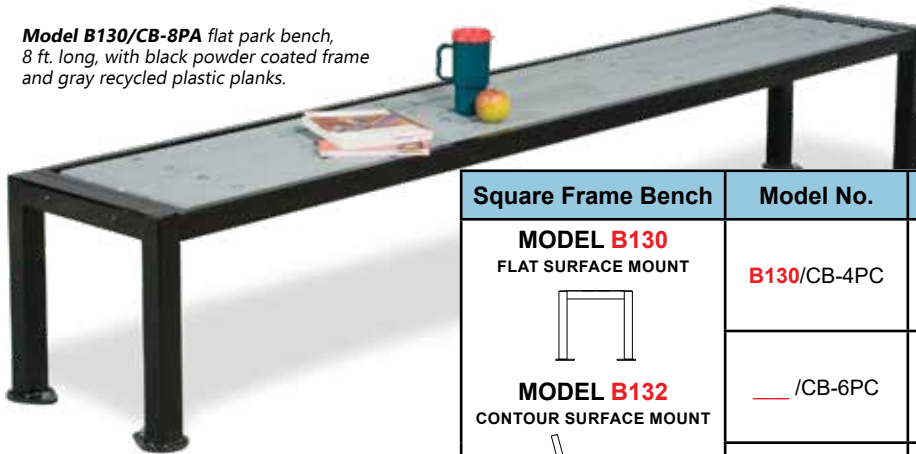

Model B132/CN-6PC contour park bench, 6 ft. long, with green powder coat frame finish and cedar colored recycled plastic planks.

Model B130/CB-8PA flat park bench, 8 ft. long, with black powder coated frame and gray recycled plastic planks.



Square Frame Bench	Model No.	Length	Seat Material	Frame Finish
MODEL B130 FLAT SURFACE MOUNT 	B130/CB-4PC	4'	1" x 4" and 2" x 4" (nom.) 100% recycled plastic in cedar color (PC) is standard. Other colors available. <i>See Page 54.</i>	Powder coat black finish (CB) on all steel components is standard. Other colors available. <i>See Page 52.</i>
MODEL B132 CONTOUR SURFACE MOUNT 	___/CB-6PC	6'		
	___/CB-8PC	8'		

- **B130 Series** Benches offer a square end frame design with inlaid planks.
- Rugged all welded end frames are 2 in. x 2 in. x 11 ga. square steel tube. Seat/backrest framework is 1 in. x 2 in. x 14 ga. rectangular steel tube, with formed steel channel reinforcements in the seat. All open ends are welded closed with steel end caps.
- Two Bench Styles:
 - **Model B130** is a flat bench.
 - **Model B132** includes a backrest and armrests.
- Surface mount installation only (anchor bolts not included). Each frame foot includes 9/16 in. dia. hole for anchor bolt. *See Page 126.*
- All steel frame components have a powder coat finish in your color choice.
- B130 Series benches can be 4, 6 or 8 ft. long.
- Seat and back inlay planks are 100% recycled plastic in your choice of color. Seat planks are 2 x 4 in. (nom.) and backrest planks are 1 x 4 in. (nom.). All inlaid planks are installed in the framework at the factory. *See Page 54.*
- Assembly of end frames to the seat/backrest components is required.



CN-Q-36 Series receptacle is a perfect match for the **B130 Series** Benches and the **T-700 Series** Tables. *See Page 67.*



Model B132/CU-6PA contour park bench, 6 ft long, with blue powder coat frame finish and gray recycled plastic planks.

RECYCLED PLASTIC BENCH - RBB & RBF Series



- RB Series Benches feature frames and planks molded from 100% recycled plastic.
- The RBB frames (with backrest) and RBF frames (flat) are 3" thick single piece solid molded plastic.
- Seat and back planks can be 2" x 4", 2" x 6", or 2" x 10" nominal dimensions, of solid molded 100% recycled plastic.
- Solid color is formed throughout plastic component. UV stabilizer added for ultraviolet protection.
- Includes stainless steel screws for assembly.
- Two sizes available:
4 ft. long benches use 2 frames.
6 ft. long benches use 3 frames.
- Frame colors: black, brown or green. Other colors available as special order.
- Seat and back planks available in many colors. *See Page 54.*
- Portable by design. Attach to surface for permanent installation with optional anchor brackets. *See Page 127.*
- **Optional:** Engraved personalization and custom laminate plaques are available. *See Pages 24-25.*
- **Optional:** See our matching planters on Page 87!



Model RBB/A-6A24 gray frames, 6 ft. long, gray 2" x 4" seat and back planks. All gray plastic offers a "concrete" look.



Model RBF/U-4Y26
blue frames, 4 ft.,
yellow 2" x 6" plastic planks



Model RBB/N-6C26 green frames, 6 ft., cedar colored 2" x 6" planks with custom engraved resin filled letters.



Model RBB/B-4A26
black frames, 4 ft.,
gray 2" x 6" plastic planks



Model RBF/C-6D26 cedar frames, 6 ft., weathered redwood 2" x 6" seat planks. Perfect for the Locker Room!



Model RBB/W-6N21 brown frames, 6 ft., green 2" x 10" plastic planks shown with optional plaque.

CHANNEL BENCH - CXB Series .

Our Most Versatile Bench

- **The CXB Series** is designed to be strong and stable with simple, clean design.
- **Model SCXB:** Stationary/embedded frame post installation.
- **Fabrication:** All welded construction; seat/back support channel is 1/8" thick (11 ga.) formed steel; frame posts are 2-3/8" OD steel pipe.
- **Standard:** Hot dip galvanized frame finish. Galvanized fasteners for assembly.
- **Optional:** Powder coat frame finish. *See Page 52.*
- **Seat/backrest material choices:** See table below.
- **Length:** 4, 6, 8, 10, 15, 21 or 24 feet long, depending on seat/back material selected.
- **Optional:** Armrests. *See Page 26*
- **Optional Custom Message:** Engraved lettering in recycled plastic material; plastic laminate plaques recessed into lumber or recycled plastic; punched lettering in perforated steel. *See Pages 24-25.*
- **Optional:** 2-part aluminum cover caps for frame post. *See Page 26.*

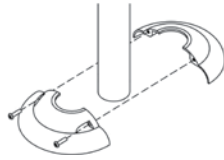

Model SCXB/CB-8HR10, embedded mount, black powder coated frames, 8 ft. long, 2" x 10" red thermo-plastic coated perforated steel seat and back planks.



Model SCXB/CB-6AU, embedded mount, 6 ft. long with black powder coated frames and blue powder coated aluminum back and seat.



Model SCXB3/CU-6PY24 embedded mount, 6 ft. long, three blue powder coated frames, 2" x 4" yellow recycled plastic planks.



Model PCXB/G-6AL, embedded mount, galvanized frames, 6 ft. long, 2" x 10" (nom.) clear anodized aluminum planks.

STATIONARY / EMBEDDED INSTALLATION			
SCXB	Material	Material Thickness and Width (in. nom.)	Bench Length (ft.)
Stationary, Embedded Frame Post 	Treated Pine Lumber	2 x 4	4, 6, 8, 15
	Aluminum	2 x 10	4, 6, 8, 15, 21, 24
	100% Recycled Plastic	2 x 4	4, 6
	Expanded Steel	2-1/2 x 10 2-1/2 x 12	4, 6, 8, 10, 16
	Perforated Steel		
	Formed Steel Channel	2 x 11	6, 8



Model PCXB/G-6TP24, portable, galvanized frames, 6 ft. long, 2" x 4" (nom.) treated pine planks.

CHANNEL BENCH - CXB Series

Our Most Versatile Bench

- **The CXB Series** is designed to be strong and stable with simple, clean design.
- **Model PCXB:** Portable/surface mount installation, 9/16" dia. anchor holes in frame foot.
- **Fabrication:** All welded construction; seat/back support channel is 1/8" thick (11 ga.) formed steel; frame posts and frame foot are 2-3/8" OD steel pipe.
- **Standard:** Hot dip galvanized frame finish. Galvanized fasteners for assembly.
- **Optional:** Powder coat frame finish. *See Page 52.*
- **Seat/backrest material choices:** See table below.
- **Length:** 4, 6, 8, 10, 15, 16, 21 or 24 feet long, depending on seat/back material selected.
- **Optional:** Armrests. *See Page 26.*
- **Optional Custom Message:** Engraved lettering in recycled plastic material; plastic laminate plaques recessed into lumber or recycled plastic; punched lettering in perforated steel. *See Pages 24-25.*
- **Optional:** Surface anchor kits. *See Page 126.*



Model PCXB3/G-15AL, portable, galvanized frames, 15 ft. long, 2" x 10" (nom.) clear anodized aluminum planks.



Model PCXB/CB-8HR12, portable, black powder coated frames, 8 ft. long, 2" x 12" (nom.) red thermo-plastic coated perforated steel seat and back with custom lettering.

PORTABLE / SURFACE MOUNT INSTALLATION			
PCXB	Material	Material Thickness and Width (in. nom.)	Bench Length (ft.)
Portable, Surface Mount Frame Foot 	Treated Pine Lumber	2 x 4	4, 6, 8, 15
	Aluminum	2 x 10	4, 6, 8, 15, 21, 24
	100% Recycled Plastic	2 x 4	4, 6
	Expanded Steel	2-1/2 x 10 2-1/2 x 12	4, 6, 8, 10, 16
	Perforated Steel		
Formed Steel Channel	2 x 11	6, 8	



Model PCXB/CW-4PN24, portable, brown powder coated frames, 4 ft. long, 2" x 4" green recycled plastic planks.

CONTEMPORARY STEEL BENCH - B120 Series

- **Model B120** all steel bench offers a contemporary design with armrests and a comfortable contour or flat bench seat.
- All heavy gauge steel fabricated components: 2-3/8" OD steel pipe frame post and surface foot, 7 ga. steel armrest, and choice of four steel seats.
- Seat materials include: 3/4-#9 expanded steel, 14 ga. perforated steel and 10 ga. cut steel plate each with thermo-plastic coating; or welded steel strap with powder coat finish. *See Pages 52, 55-57 for colors.*
- Frame posts and armrests are powder coated. *See Page 52 for colors.*
- **Installation:** Surface mount and embedded post designs available.
- 4, 6, or 8 ft. lengths.
- **Optional:** #ANC3-4 concrete screw anchors for surface mounting. *See Page 126.*
- **Optional:** 2-part aluminum cover caps for B121 and B123 frame posts. *See Page 26.*

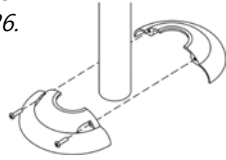

Model B122/CN-4SP/TR contour bench, surface mount, green powder coated frames, 4 ft., cut steel plate seat with red thermo-plastic coating. Shown with optional custom lettering.



Model B121/CB-4SS/CY embedded mount flat bench, black powder coated frames, 4 ft. long, with yellow powder coated steel strap seat.

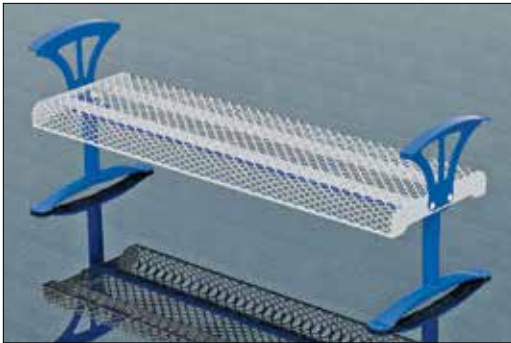

Model B120/CU-6DA flat bench, surface mount, blue powder coated frames, 6 ft., expanded steel seat with gray thermo-plastic coating.



Model B122/CU-4RO contour bench, surface mount, blue powder coated frames, 4 ft., perforated steel seat with orange thermo-plastic coating.



Model B122/CB-6DU contour bench, surface mount, black powder coated frames, 6 ft., expanded steel seat with blue thermo-plastic coating.

STEEL BENCH	MODEL NO. Insert Model Number prefix for bench style choice	LENGTH (FEET)	SEAT MATERIAL	FRAME FINISH
MODEL B120 FLAT SURFACE MOUNT 	B120/CB-4DW	4	Standard Finishes: (Brown) Thermo-plastic Coated Expanded Steel (DW) (Brown) Thermo-plastic Coated Perforated Steel (RW) (Brown) Thermo-plastic Coated Cut Steel Plate (SP/TW) Other color choices available, <i>see Pages 55-57.</i> or (Black) Powder Coated Steel Strap (SS/CB) Other color choices available, <i>see Page 52.</i>	Powder Coated Black finish (/CB) on frames and armrests is standard. Other colors available, <i>see Page 52.</i>
MODEL B121 FLAT EMBEDDED MOUNT 	___/CB-6DW	6		
MODEL B122 CONTOUR SURFACE MOUNT 	___/CB-8DW	8		
MODEL B123 CONTOUR EMBEDDED MOUNT 	___/CB-8DW	8		

ACCESSIBLE BENCH - B110C Series



- The full-length grab bar across the back of the bench enhances access and transfer to or from this bench.
- All welded frame fabrication: seat/back support channel is die-formed 1/8" thick (11 ga.) steel, frame post and portable/surface mount foot are 2-3/8" OD steel pipe.
- Hot dip galvanized finish is standard.
- **Optional:** Powder coat finish. *See Page 52 for colors.*
- **Model B110C:** 6 ft., surface mount, grab bar 35" high, seat width 20", seat height 18-1/2" (nom. dimensions), includes 9/16" dia. anchor holes in foot. *See Page 126 for optional anchor bolts.*
- **Model B111C:** 6 ft. embedded frame installation.
- Seat/back plank materials include 2" x 4" (nom.) treated pine, or 100% recycled plastic. *See Page 54 for color choices.*
- **Optional:** Custom engraved lettering on recycled plastic; or plastic laminate plaques are available on lumber and recycled plastic. *See Pages 24-25.*
- **Optional:** 2-part aluminum cover caps for B111C frame posts. *See page 26.*

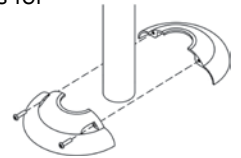

(Above) **Model B111C/CR-6PA24** accessible bench, red powder coat frames, 6 ft., 2" x 4" gray recycled plastic seat planks, illustrating embedded installation.



(Right) **Model B110C/G-6TP24** accessible bench, hot dip galvanized frames, 6 ft., 2" x 4" treated lumber seat planks.

CLASSIC BENCH - CLB Series

- **Model CLB** Bench incorporates one-piece welded end frames, die formed from structural channel, strong, light weight design. Diagonal braces provide support and stability.
- Portable/surface mount with anchor holes in frame feet. *(Anchors not included.) See Page 126.*
- Frames are hot dip galvanized after fabrication for maximum protection from weather.
- Lengths: 4 or 6 ft. long.
- Lumber: 3/4" x 3" Redwood stained hardwood slats. (6 ft. model uses additional formed center channel for support).
- 100% Recycled Plastic: 1" x 3" (nom.) seat/back slats of 100% recycled plastic available in many colors. *See Page 54.* (4 ft. bench uses extra formed center channel for support. 6 ft. bench uses 3 frames.)



Model CLB/G-4HW, 4 ft., redwood stained hardwood slats.



Model CLB/G-6HW, 6 ft. long, redwood stained hardwood slats.



Model CLB3/G-6PC13, 3 frames, 6 ft. long, 100% recycled plastic slats, cedar color.



Model CLB/G-4PN13, 4 ft. long, 100% recycled plastic slats, green color.

CONTOUR BENCH - WRB & OWRB Series

Available in two different frame styles:

- **WRB Series Bench** uses 2 to 3 frame posts.
 - **Model PWRB:** portable/surface mount.
 - **Model SWRB:** stationary/embedded frame post installation.
- WRB Series Benches offer all welded frame construction, 2-1/2" sq. steel tube for leg post, 3/8" thick steel for seat support bracket and portable model frame foot.
- **OWRB Series Bench** uses a single larger central support post for a permanent location.
 - **Model OWRB:** embedded post installation.
 - **Model OWRB/P:** surface mount with 3/8" x 10" sq. bolt down base plate.
- OWRB Series Benches offer single piece all welded frame construction, a 4" sq. steel tube support post, a 2-1/2" sq. steel tube crossarm, and 3/8" thick steel seat supports.

Both Contour Bench models offer:

- Seat timber choices: 3" x 4" (nom.) construction heart redwood lumber, or 3" x 4" 100% recycled plastic timbers in many colors. *See Pages 53-54.*
- Frame finish: Hot dip galvanized or powder coated in choice of colors.
- **Optional:** Armrests help make benches more accessible. *See Page 26.*
- **Optional:** Engraved personalization on recycled plastic, or custom laminate plaques available on lumber and recycled plastic. *See Pages 24-25.*
- **Optional:** Anchor kits for surface mounting Models PWRB and OWRB/P. *See Page 126.*



(Right) **Model OWRB** illustrating standard embedded frame post installation.



Model SWRB3/CR-6PQ34
Contour embedded mount, red powder coated frames, 6 ft. long, 3" x 4", recycled plastic timbers, in multi-color. Plus your custom engraved message.



Model PWRB3/G-6PR34
portable, galvanized frames, 6 ft. long, 3" x 4" recycled plastic timbers in red color. Shown with optional **AR/G-4PR** arm rests and optional custom plaque.



Model OWRB/P/G-6CO34 surface installation with optional base plate, hot dip galvanized frame, 6 ft. long, 3" x 4" construction heart redwood timbers.

WRB SERIES	FRAME POSTS	MODEL NO. <small>Insert Model Number prefix for bench style & length</small>	LENGTH (FEET)	SEAT MATERIAL	FRAME FINISH
MODEL PWRB PORTABLE/SURFACE MOUNT	Twin posts, 2-1/2" sq. steel tube.	PWRB/G-4 CO34	4, 6, 8	3" x 4" (nominal) Construction Heart Redwood (CO). <i>See Page 53.</i>	A Hot Dip Galvanized finish (IG) applied after fabrication is standard. Powder Coated Black finish (ICB) is also available on this model. Other colors available, <i>see Page 52.</i>
MODEL SWRB EMBEDDED POST MOUNT	Note: 6' & 8' benches with recycled plastic have (3) frames.	SWRB/G-__34			
MODEL OWRB EMBEDDED POST MOUNT	Single Post, 4" sq. steel tube, with 2-1/2" sq. steel tube cross arm	OWRB/G-__34	4, 6	3" x 4" (nominal) Cedar colored (PC) 100% Recycled Plastic. Other colors available, <i>see Page 54.</i>	
MODEL OWRB/P SURFACE MOUNT BASE PLATE INSTALL	Note: 6' bench with recycled plastic has (3) seat supports.	OWRB/P/G-__34			

TRAILSIDE BENCH - WB & OWB Series

Available in two different frame styles:

- **WB Series Trailside Bench** uses 2 to 3 frame posts.
 - **Model PWB:** portable/surface mounted.
 - **Model SWB:** stationary/embedded frame post installation.
- WB Trailside Benches offer all welded frame fabrication, 2-1/2" sq. steel tube for leg posts, 3/8" thick steel for seat bracket and portable model frame foot.
- WB Benches can be 4, 6 or 8 ft. long, seat is 16 in. wide (nom.). The number of frames depends on the length and seat material chosen.
- **OWB Series Trailside Bench** uses a single center post for a permanent location.
 - **Model OWB:** embedded post installation.
 - **Model OWB/P:** surface mount with 3/8" x 10" sq. bolt down base plate.
- OWB Trailside Bench uses a single 4" square steel tube center post with a 2-1/2" sq. cross seat support.
- OWB Benches can be 4 or 6 feet long, seat is 24" wide (nom.).

Both Trailside Benches offer:

- Hot dip galvanized frame finish and galvanized fasteners.
- **Optional:** Powder coated frame finish. *See Page 52.*
- Seat timber materials include: 3" x 4" (nom.) construction heart redwood lumber, or 3" x 4" (nom.) 100% recycled plastic. *See Pages 53-54.*
- **Optional:** Concrete screw type anchors are available for Model PWB and OWB/P surface mount bench frames. *See Page 126.*



Model SWB3/G-6PC34, embedded, galvanized frames, 6 ft. long, cedar colored recycled plastic 3" x 4" (nom.) seat timbers.







Model PWB/G-4PN34, portable, shown with optional AR/G-6PN armrests.



Model OWB/CR-4PU34, embedded, red powder coated frames, 4 ft. long, blue colored recycled plastic 3" x 4" (nom.) seat timbers.



Model OWB/P/CB-6CO34 surface mount, 6 ft. long, with 3" x 4" (nom.) construction heart redwood seat timbers.

WB/OWB SERIES	FRAME POSTS	MODEL NO. <small>Insert Model Number prefix for bench style & length</small>	LENGTH (FEET)	SEAT MATERIAL	FRAME FINISH
MODEL PWB PORTABLE/SURFACE MOUNT 	Twin posts, 2-1/2" sq. steel tube. Note: 6' & 8' benches with recycled plastic have (3) frames.	PWB/G- <u>4</u> CO34	4, 6, 8	3" x 4" (nominal) Construction Heart Redwood (CO). <i>See Page 53.</i> or 3" x 4" (nominal) Cedar colored (PC) 100% Recycled Plastic. Other colors available, <i>see Page 54.</i>	A Hot Dip Galvanized finish (/G) is standard. Powder Coated Black finish (/CB) is also available on this model. Other colors available, <i>see Page 52.</i>
MODEL SWB EMBEDDED POST MOUNT 		SWB/G-__34			
MODEL OWB EMBEDDED POST MOUNT 	Single Post, 4" sq. steel tube, with 2-1/2" sq. steel tube cross arm	OWB/G-__34	4, 6		
MODEL OWB/P SURFACE MOUNT BASE PLATE INSTALL 		OWB/P/G-__34			

AMHERST BENCH - B100 Series

- All steel fabrication. 3/16" thick (7 ga.) steel seat and back sections. 2" sq. x 11 ga. wall steel tube frame structures.
- 6 ft. long. Two styles:
 - **Model B100:** Flat (no back)
 - **Model B102:** Contour (with back)
- Portable/surface mount with anchor holes in frame feet.
- Powder coated finish. Choice of colors. *See Page 52.*
- Simple to assemble. Contour bench has only 4 pieces: seat, back and 2 frames. Flat bench has only 3 pieces.
- **Optional:** Round metal plaques. *See Page 24.*
- **Optional:** Surface anchor kits. *See Page 126.*
- Match with the Amherst Trash Receptacle. *See Page 63.*
- Alternate backrest designs available. *Samples shown below.*
- Or your own custom design!!

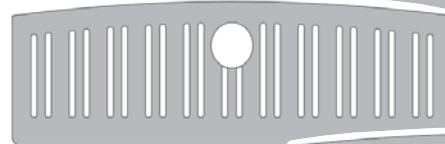
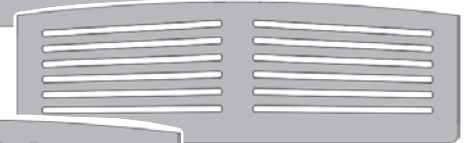

Wall Mount BENCH - WMB Series

- **Model WMB** Wall Mount Bench is a natural for pools, athletic facilities, locker rooms, building entrances, and parks.
- Bench can be 4 ft. long (two frames), 6 or 8 ft. (three frames), or 8 ft. long with plastic seat planks (four frames).
- Wall bracket is 10 ga. formed/welded channel, galvanized finish.
- No floor obstructions, easy floor maintenance.
- **Optional:** Powder coat frame finish in choice of colors. *See Page 52.*
- Includes galvanized fasteners to attach seat to frame. Does not include wall anchors (each bracket includes three 7/16" dia. wall anchor holes).

Seat Materials	Plank Size (nom.)	Seat Width	Front Edge to Wall
Treated Pine	2" x 4"	11"	14-1/2"
100% Recycled Plastic	2" x 4"	11"	14-1/2"
Aluminum	2" x 10"	10"	15-1/2"
Expanded / Perforated Steel	2-1/2" x 12"	12"	14-3/16"
Formed Steel Channel 6', 8'	2" x 11"	11"	14-1/2"



Model WMB/G-4PC24 Wall Mount Bench, 4 ft., two galvanized frames, 2" x 4" Cedar colored recycled plastic seat planks.



Model WMB3/G-6PU24 Wall Mount Bench, 6 ft., three hot dip galvanized frames, 2" x 4" blue recycled plastic seat.



Model WMB3/G-8VN12 Wall Mount Bench, 8 ft., hot dip galvanized frames, 12" wide green thermo-plastic coated expanded steel seat.



Model BC4001/CB-6PC, black frames, 6 ft. long, cedar colored planks with optional plaque.



Model BC3001/CN-6PN, green frames, 6 ft. long, green planks.

PARK AVENUE BENCH - BC3001/4001 Series

- Comfortable, classic styling using low maintenance components.
- 2 seating styles: Flat or with backrest in 4, 5, 6, or 8 ft. lengths (8 ft. benches use 3 frames).
- Cast aluminum frames. Available in 6 colors of polyester powder coat finish: hunter green, red, brown, black, dark gray, white.
- Seat and backrest planks are 2" x 4" (nominal) 100% recycled plastic. Available in many colors. *See Page 54.*
- Portable/surface mount frame design. Frame feet include anchor holes to secure to surface.
- **Optional:** Surface anchor kits. *See Page 126.*

GREY CREEK BENCH - B30 Series

- Rugged, welded steel component frame structures, offering a wide-surface armrest made with flat steel plate.
- Surface mount or embedded installation.
- Frames can be hot dip galvanized or powder coated with your choice of colors. *See Page 52.*
- All end frames have armrests for improved access and comfort.
- Contour style or flat designs available in 4, 6, or 8 ft. lengths.
- 6 ft. benches with plastic timbers and all 8 ft. long benches have a center support without armrest.
- Seat timbers are 3" x 4" (nom.) available in: construction heart redwood or 100% recycled plastic. *See Pages 53-54.*
- **Optional:** Engraved personalization on recycled plastic. Plastic laminate plaques on lumber and recycled plastic. *See Page 24.*
- **Optional:** Surface mount anchors available. *See Page 126.*



Model B31C/G-6PN34, flat, embedded mount, hot dip galvanized frames, 6 ft. long, with 3" x 4" green recycled plastic timbers.



Model B32C/CN-8CO34, contour, surface mount, green powder coated frames, 8 ft. long, with 3" x 4" construction heart redwood timbers.



Model B32/CB-4PA34, surface mount, black powder coated frames, 4 ft. long, with 3" x 4" grey recycled plastic timbers.



Model B31/CB-6CO34, flat, embedded mount, black powder coated frames, 6 ft. long, with 3" x 4" construction heart redwood timbers.

GREY CREEK SERIES	MODEL NO. Insert Model Number prefix for bench style choice	LENGTH (FEET)	SEAT MATERIAL	FRAME FINISH		
MODEL B30 FLAT SURFACE MOUNT 	___/CB-4CO34	4	3" x 4" (nominal) Construction Heart Redwood (CO) is standard. <i>See Page 53.</i>	Powder Coated Black finish (/CB) is standard. Other colors available, <i>see Page 52.</i>		
	___/CB-6CO34	6				
MODEL B31 FLAT EMBEDDED MOUNT 	___C/CB-8CO34	8				
	___/CB-4PC34	4				
MODEL B32 CONTOUR SURFACE MOUNT 	___C/CB-6PC34	6			3" x 4" (nominal) Cedar colored (PC) 100% Recycled Plastic is standard. Other colors available, <i>see Page 54.</i>	A Hot Dip Galvanized finish (/G) applied after fabrication also available on this model.
	___C/CB-8PC34	8				
MODEL B33 CONTOUR EMBEDDED MOUNT 	___C/CB-8PC34	8				



SILVER SIOUX BENCH - B40 Series

- Welded steel component frame fabrication for strength, round steel tube armrests for a softer appearance.
- Surface mount or embedded installation.
- Frames are powder coated in your choice of colors. *See Page 52.*
- All end frames have armrests for improved access and comfort.
- Contour style or flat designs available in 4, 6, or 8 ft. lengths.
- 6 ft. benches with plastic timbers and all 8 ft. long benches have a center support without armrest.
- Seat timbers are 3" x 4" available in construction heart redwood or 100% recycled plastic. *See Pages 53-54.*
- **Optional:** Engraved personalization on recycled plastic. Plastic laminate plaques on lumber and recycled plastic. *See Page 24.*
- **Optional:** Surface mount anchors available. *See Page 126.*
- **Optional:** 2-part aluminum cover caps for B41 and B43 frame posts. *See page 26.*

Model B42C/CN-6PC34 contour, surface mount bench, 6 ft. long, with green powder coated frames and 3" x 4" cedar colored recycled plastic timbers



Model B40/CB-4CO34, black powder coated frames, 4 ft. long, with 3" x 4" construction heart redwood timbers



Model B42/CW-4PN34 contour, surface mount bench, 4 ft. long, with brown powder coated frames and green recycled plastic timbers



Model B41C/CB-8PD34, flat, embedded mount bench with black powder coated frames, 8 ft. long, 3" x 4" weathered wood recycled plastic timbers.

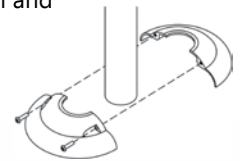

SILVER SIOUX SERIES	MODEL NO. Insert Model Number prefix for bench style choice	LENGTH (FEET)	SEAT MATERIAL	FRAME FINISH
MODEL B40 FLAT SURFACE MOUNT 	___/CB-4CO34	4	3" x 4" (nominal) Construction Heart Redwood (CO) is standard. <i>See Page 53.</i>	Powder Coated Black finish (/CB) is standard. Other colors available, <i>see Page 52.</i>
	___/CB-6CO34	6		
MODEL B41 FLAT EMBEDDED MOUNT 	___C/CB-8CO34	8		
MODEL B42 CONTOUR SURFACE MOUNT 	___/CB-4PC34	4	3" x 4" (nominal) Cedar colored (PC) 100% Recycled Plastic is standard.	
	___C/CB-6PC34	6		
MODEL B43 CONTOUR EMBEDDED MOUNT 	___C/CB-8PC34	8	Other colors available, <i>see Page 54.</i>	



RIVERVIEW BENCH - B60 Series

- Heavy steel pipe fabrication. Welded steel components for a stronger frame. Wider curves for a simple, clean appearance.
- Surface mount or embedded installation.
- Powder coated frames in your choice of colors. *See Page 52.*
- All frames have armrests for improved access and comfort.
- 2 Bench Styles: Contour or flat. Available in 4 or 6 ft. lengths.
- Seat timbers are 3" x 4" (nom.). Available in: construction heart redwood or 100% recycled plastic. Plastic timbers available in 4 ft. lengths only. *See Pages 53-54.*
- **Optional:** Engraved personalization on recycled plastic. Plastic laminate plaques on lumber and recycled plastic. *See Page 24.*
- **Optional:** Surface mount anchors available. *See Page 126.*
- **Optional:** 2-part aluminum cover caps for all B60 bench frame posts. *See Page 26.*



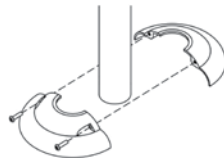

Model B60/CN-4CO34 flat, surface mount, 4 ft. bench. Shown with green powder coated frames and 3" x 4" construction heart redwood timbers.



Model B63/CW-4PC34, contour, embedded mount bench, brown powder coated frames, 4 ft. long with 3" x 4" cedar colored recycled plastic timbers.

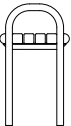

Model B63/CU-4PD34, 4 ft. long, blue powder coat frames, 3" x 4" weathered wood colored recycled plastic seat timbers.

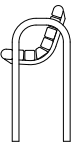
RIVERVIEW SERIES	MODEL NO. <small>Insert Model Number prefix for bench style choice</small>	LENGTH (FEET)	SEAT MATERIAL	FRAME FINISH
MODEL B60 FLAT SURFACE MOUNT 	B60/CB-4CO34	4	3" x 4" (nominal) Construction Heart Redwood (CO) is standard. <i>See Page 53.</i>	Powder Coated Black finish (CB) is standard. Other colors available, <i>see Page 52.</i>
MODEL B61 FLAT EMBEDDED MOUNT 	___/CB-6CO34	6		
MODEL B62 CONTOUR SURFACE MOUNT 	___/CB-4PC34	4	3" x 4" (nominal) Cedar colored (PC) 100% Recycled Plastic is standard. Other colors available, <i>see Page 54.</i>	
MODEL B63 CONTOUR EMBEDDED MOUNT 				

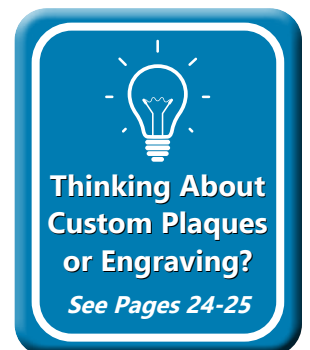



Model B78/CB-6DN
surface mount, contour, black powder coated frames, 6 ft., thermo-plastic coated expanded steel in green. Shown with optional AR/CB-13 center armrest.

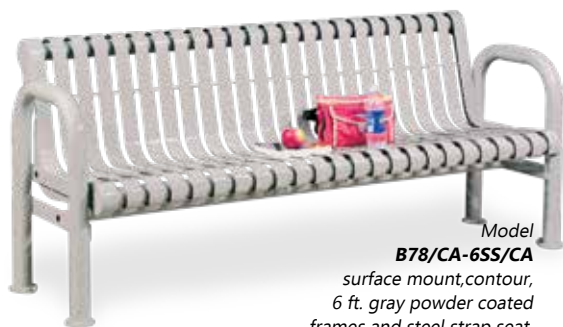

Model
B78/CA-6SS/CA
surface mount, contour, 6 ft. gray powder coated frames and steel strap seat.



Model B77/CN-6DN embedded, flat, green powder coated frames, 6 ft., thermo-plastic coated expanded steel in green.

RIVERVIEW BENCH - B70 Series

- Heavy steel pipe fabrication. Welded steel components for a stronger frame. Wider curves for a simple, clean appearance.
- Surface mount or embedded installation.
- Powder coated frames in your choice of colors. *See Page 52.*
- All frames have armrests for improved access and comfort.
- **Four seat design materials.** *See Pages 52, 55-57 for colors.*
 - 3/4-#9 expanded steel with thermo-plastic coating.
 - 14 ga. perforated steel with thermo-plastic coating.
 - 10 ga. cut steel plate pattern with thermo-plastic coating.
 - Steel strap seat with powder coat finish.
- Available in 4, 6 or 8 ft. lengths. Flat or contour styles.
- **Optional:** Model AR/C-13 center armrest for contour seats using expanded or perforated steel. *See Page 26.*
- **Optional:** Surface mount anchors available. *See Page 126.*
- **Optional:** 2-part aluminum cover caps for all B70 bench frame posts. *See Page 26.*

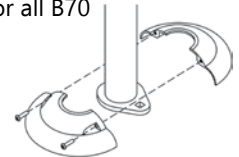

(above)
Model B78/CB-4RY
4 ft. long surface mount bench with black powder coat frames and yellow thermo-plastic coated perforated steel contour seat.

RIVERVIEW SERIES	MODEL NO. Insert Model Number prefix for bench style choice	LENGTH (FEET)	SEAT MATERIAL	FRAME FINISH
MODEL B76 FLAT SURFACE MOUNT 	B76/CB-4DW	4	Brown Thermo-plastic Coated Expanded Steel (DW) or Perforated Steel (RW) is standard. Other color choices available, <i>see Page 56-57.</i>	Powder Coated Black finish (/CB) is standard. Other colors available, <i>see Page 52.</i>
MODEL B77 FLAT EMBEDDED MOUNT 	___/CB-6DW	6		
MODEL B78 CONTOUR SURFACE MOUNT 	___/CB-8DW	8	Black Powder Coated Steel Strap (SS/CB) Other color choices available, <i>see Page 52.</i>	
MODEL B79 CONTOUR EMBEDDED MOUNT 				

GILLETTE BENCH - B80 Series



Model B80/CN-4SS
4 ft. flat bench, steel strap seat, green powder coat finish.



Model B82/CB-4CO34
4 ft. contour bench, black powder coat frames, construction heart redwood seat.



Model B80/CN-6PY34
6 ft. flat bench, green powder coat finish, yellow recycled plastic seat.



Model B80/CW-6SP
6 ft. flat bench, cut steel plate seat, brown powder coat finish.



Optional laminate plaque available on contour benches featuring lumber or recycled plastic.



Model B82/CB-6SS
6 ft. contour bench, steel strap seat, black powder coat finish. Shown with optional round metal plaque.

- Heavy cast iron end frames with a powder coat paint finish. *See Page 52.*
- Two seat styles: Flat or contour, with surface mount installation. 4 ft., 6 ft., or 8 ft. long. All stainless steel fasteners for assembly.
- Four seat and back material choices:
 - Construction Heart Redwood, in 3" x 4" (nom.) sized timbers. *See Page 53.*
 - 100% Recycled Plastic in 3" x 4" (nom.) sized timbers. *See Page 54.*
 - Steel strap fabrication (SS), heavy gauge steel, and all welded construction, with powder coat finish. The frame components and seat structure will be powder coated in the same color.
 - Steel Plate seat design (SP) is a diamond pattern cut and formed from a single sheet of 10 ga. steel, and finished with powder coat paint.
- **Optional:** Engraved personalization on recycled plastic. Plastic laminate plaques on lumber and recycled plastic. Custom cut letters can be incorporated into the Steel Plate (SP) backrest design. Round metal plaques can be recessed into the backrest of the Steel Strap (SS) and Cut Steel Plate (SP) style seat. *See Pages 24-25 for signage details.*
- **Optional:** Surface anchor kits. *See Page 126.*

See our Matching Planters on Page 87!

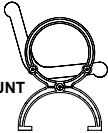
GILLETTE SERIES	MODEL NO. <small>Insert Model Number prefix for bench style choice</small>	LENGTH (FEET)	SEAT MATERIAL	FRAME FINISH
MODEL B80 FLAT SURFACE MOUNT 	B80/CB-4CO34	4	3" x 4" (nominal) Construction Heart Redwood (CO) is standard.	Powder Coated Black finish (/CB) is standard. Other colors available, <i>see Page 52.</i>
	___/CB-6CO34	6		
	___/CB-8CO34	8		
	___/CB-4PC34	4	3" x 4" (nominal) Cedar colored (PC) 100% Recycled Plastic is standard. Other colors available, <i>see Page 54.</i>	
	___/CB-6PC34	6		
	___/CB-8PC34	8		
MODEL B82 CONTOUR SURFACE MOUNT 	___/CB-4SS	4	Heavy gauge Steel Strap seat (SS) fabrication with all steel component support structure, all welded construction, with powder coat paint finish, <i>see Page 52.</i>	
	___/CB-6SS	6		
	___/CB-8SS	8		
	___/CB-4SP	4	Steel Plate seat design (SP) is a diamond pattern cut and formed from a single sheet of 10 ga. steel, and finished with powder coat paint, <i>see Page 52.</i>	
	___/CB-6SP	6		
	___/CB-8SP	8		

OAK KNOLL BENCH - B90 Series

- Two seat styles: Contour with cast aluminum frames with armrests. Flat with cast iron end frames. Powder coat paint frame finish in your choice of colors. *See Page 52.*
- Surface mount installation. 4 ft., 6 ft., or 8 ft. long. All stainless steel fasteners for assembly.
- Four seat and back material choices:
 - Construction Heart Redwood, 3" x 4" (nom.) sized timbers. *See Page 53.*
 - 100% Recycled Plastic 3" x 4" (nom.) sized timbers. *See Page 54 for colors.*
 - Steel strap fabrication (SS), heavy gauge steel, and all welded construction, with powder coat finish. The frame components and seat structure will be powder coated in the same color.
 - Steel Plate seat design (SP) is a diamond pattern cut and formed from a single sheet of 10 ga. steel, and finished with powder coat paint.
- **Optional:** Engraved personalization on recycled plastic. Plastic laminate plaques on lumber and recycled plastic. Custom cut letters can be incorporated into the Steel Plate (SP) backrest design. Round metal plaques can be recessed into the backrest of the Steel Strap (SS) and Cut Steel Plate (SP) style seats. *See Pages 24-25 for signage details.*
- **Optional:** Surface anchor kits. *See Page 126.*
- **Optional:** Model AR-10 cast iron armrest, bolted in center, is available for contour Steel Strap and Steel Plate seat designs (not available on wood or plastic). Will be same color as bench. *See Page 26.*



Model B94/CB-6SS
6 ft. contour bench, black powder coat finish, steel strap seat.

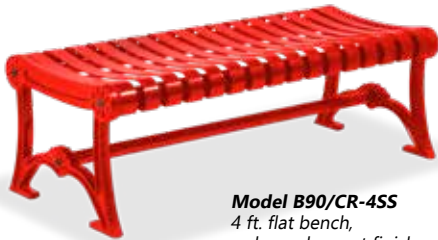

Model B90/CR-4SS
4 ft. flat bench, red powder coat finish, steel strap seat.

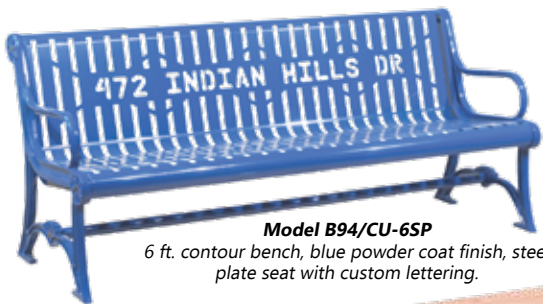

Model B94/CU-6SP
6 ft. contour bench, blue powder coat finish, steel plate seat with custom lettering.



Check out our Matching Planters on Page 87!



Model B90/CB-4CO34
4 ft. flat bench, black powder coat frames, construction heart redwood seat.



Model B94/CN-6SP
6 ft. contour bench, green powder coat finish, cut steel seat, optional **Model AR-10** center armrest.

OAK KNOLL SERIES	MODEL NO. Insert Model Number prefix for bench style choice	LENGTH (FEET)	SEAT MATERIAL	FRAME FINISH
MODEL B90 FLAT SURFACE MOUNT CAST IRON 	B90/CB-4CO34	4	3" x 4" (nominal) Construction Heart Redwood (CO) is standard.	Powder Coated Black finish (/CB) is standard. Other colors available, <i>see Page 52.</i>
	___/CB-6CO34	6		
	___/CB-8CO34	8		
	___/CB-4PC34	4	3" x 4" (nominal) Cedar colored (PC) 100% Recycled Plastic is standard. Other colors available, <i>see Page 54.</i>	
	___/CB-6PC34	6		
	___/CB-8PC34	8		
MODEL B94 CONTOUR SURFACE MOUNT CAST ALUMINUM 	___/CB-4SS	4	Heavy gauge Steel Strap seat (SS) fabrication with all steel component support structure, all welded construction, with powder coat paint finish, <i>see Page 52.</i>	Frame components and seats shall have Black powder coat finish as standard (/CB). Other colors available, <i>see Page 52.</i>
	___/CB-6SS	6		
	___/CB-8SS	8		
	___/CB-4SP	4	Steel Plate seat design (SP) is a diamond pattern cut and formed from a single sheet of 10 ga. steel, and finished with powder coat paint, <i>see Page 52.</i>	
	___/CB-6SP	6		
	___/CB-8SP	8		

TEAM BENCH WITH EQUIPMENT DECK - B300 Series

- **Series B300** Team Bench available as:
 - Model B302:** 6 or 8 ft. long, 2 frames;
 - Model B303:** 12 or 15 ft. long, 3 frames;
 - Model B304:** 21 ft. long, aluminum only, 4 frames.
- End frames are one-piece, welded construction with a die-formed back, seat, and deck bracket of 2-3/8" x 1-1/2" x 1/8" nom. steel channel, and a 2-3/8" O.D. steel pipe.
- Includes 2" x 10" (nom.) seat and backrest planks for the team. Plus a 20" (nom.) wide (2 planks) full length deck behind the bench for stowing equipment bags and gear.
- Frame can be anchored to hard surface. Each frame includes two 7/16" dia. holes for anchor bolts (not included). The wide frame base makes this a stable bench on turf.
- **Standard:** Hot dip galvanized finish on frames.
- **Standard:** Aluminum planks with clear anodized finish.
- **Optional:** Powder coat finish on frames. *See Page 52.*
- **Optional:** Powder coat finish on aluminum planks.
- **Optional:** Concrete screw type anchors. *See Page 126.*
- **Optional:** 2" x 10" (nom.) pressure treated #1 southern yellow pine planks instead of aluminum planks.

Provides room for the players & their gear!



Model B302/G-8AL Team Bench, hot dip galvanized frames, 8 ft. clear anodized aluminum seat and deck planks.



Model B303/CB-12AY Team Bench, black powder coated frames, 12 ft. long, yellow powder coated aluminum seat and deck planks.



B303/G-12TP21 Team Bench, three hot dip galvanized frames, 12 ft. long 2" x 10" treated pine seat and deck planks.

B300 SERIES	MODEL NO. Insert Length & Material where applicable	LENGTH (FEET)	SEAT MATERIALS	FRAME FINISH	ALUMINUM FINISH	OPTIONAL SURFACE ANCHORS
MODEL B302 2 FRAMES	B302/G-6___	6, 8	2" x 10" (nominal) Clear Anodized Aluminum (AL)	A Hot Dip Galvanized finish (/G) is standard.	Clear Anodized (AL) is standard.	ANC2-4
MODEL B303 3 FRAMES	B303/G-12___	12, 15	or Treated Pine (TP)	Powder Coated Black finish (/CB) is also available on this model. Other colors available, <i>see Page 52.</i>	or Powder coated in choice of colors (6', 8', 12' only), <i>see Page 52.</i>	ANC2-6
MODEL B304 4 FRAMES	B304/G-21AL	21	2" x 10" (nominal) Clear Anodized Aluminum (AL)		Clear Anodized (AL) Only.	ANC2-4 <i>will need (2) kits per bench</i>

Model SAB/G-6AL
stationary embedded
post, galvanized
frames, 6 ft. long,
2" x 10" clear anodized
aluminum seat.



ATHLETIC BENCH - AB Series Round Post Portable or Stationary Use

- Durable bench for schools, ball fields, pools, locker rooms and athletic facilities of all kinds.
- **AB Series Bench** is flat (no backrest).
- **Model PAB:** Portable/surface mount, 9/16" dia. anchor holes in frame foot.
- **Model SAB:** Stationary/embedded frame installations.
- **Model SAB/P:** Stationary mount with bolt-down base plate.
- All welded frame construction: 3/16" seat angle; frame posts and portable foot are fabricated from 2-3/8" OD steel pipe.
- **Standard:** Hot dip galvanized frame finish and galvanized fasteners.

Available Materials. See Pages 52-57	Lengths (feet)
2x10 Pressure Treated Pine	4, 6, 8, 15
2x10 Aluminum - clear anodized finish	4, 6, 8, 15, 21, 24
2x10 Aluminum - powder coat paint finish	4, 6, 8
2-1/2x10 or 2-1/2x12 Thermo-plastic coated, V-type Expanded Steel, or H-type Perforated Steel	4, 6, 8
2x11 Thermo-plastic coated formed Steel Channel	6, 8

- **Optional:** Powder coated frame finish. See Page 52.
- **Optional:** Thermo-plastic coated perforated steel seats (12 in. wide only) can be lettered for team or field identification. See Page 25.
- **Optional:** Surface anchor kits for PAB and SAB/P frames. See Page 126.
- **Optional:** 2-part aluminum cover caps for SAB and SAB/P frame parts. See page 26.

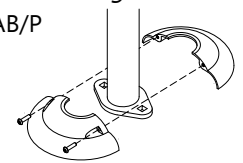

Model PAB/G-6VW10,
portable, galvanized frames, 6 ft. long,
2" x 10" (nom.) brown thermo-plastic
coated expanded steel seat plank.



Model SAB/P/CA-4HR10,
stationary surface
mount, gray powder
coated frames,
4 ft. long, 10" wide
red thermo-plastic
coated perforated
steel seat plank.

ATHLETIC BENCH - APB Series Rectangular Post Stationary Use

- Durable bench for schools, ball fields, pools, locker rooms and athletic facilities of all kinds.
- **Model APB** with embedded frame posts provides a secure, permanent location.
- **Model APB/P** frame posts have 1/4" x 8" sq. steel bolt down base plates (anchor bolts not included).
- Bench can be 4, 6, or 8 ft. long.
- Two heavy pedestal posts of 3" x 6" x 1/8" wall rectangular steel tubing. Exposed ends of frame posts are sealed with welded on end caps.
- **Standard:** Hot dip galvanized frame finish and galvanized fasteners.
- **Optional:** powder coated frame finish available in choice of colors. See Page 52.

Available Materials. See Pages 52-57	Lengths (feet)
2x10 Pressure Treated Pine	4, 6, 8
2x10 100% Recycled Plastic	4, 6, 8
2x10 Aluminum - clear anodized or powder coat paint finish	4, 6, 8
2-1/2x10 or 2-1/2x12 Thermo-plastic coated V-type Expanded Steel or H-type Perforated Steel	4, 6, 8
2x11 Thermo-plastic coated formed Steel Channel	6, 8

- **Optional:** Thermo-plastic coated perforated steel seats (12 in. wide only) can be lettered for team or field identification. See Page 25.
- **Optional:** Surface anchor kits for APB/P frames. See Page 126.



Model APB/P/G-6VA10
optional base plate
installation, galvanized
frames, 6 ft., expanded steel,
gray thermo-plastic coating,
10" wide.



Model APB/G-8HR12 embedded
installation, galvanized frames,
8 ft. long, perforated steel with red
thermo-plastic coating, 12" wide.

SIGN BENCH - B400 Series Contour Seating

- All steel fabrication with 10 ga. cut steel formed contour seat and sign frame.
- Thermo-plastic seat coating in your choice of colors.
See Pages 55.
- Frame legs are 2-3/8 in. OD steel pipe.
- Embedded frame post or surface mount installation.
(Anchors not included, see Page 126).
- Powder coat frame finish in your choice of colors. *See Page 52.*
- Includes seat dividers (bolt on) for 6 ft. and 8 ft. benches.
- Includes steel plates on bench frames for a custom decal if desired (identify a bus stop, street address, ownership, etc.). See **D**.
- **Optional:** 2-part aluminum cover caps for B400 and B401 frame posts. *See Page 26.*

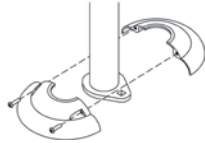

Recognize achievement, a donation, or memorial.
Get the word out. Promote an event.



Model B400/CR-8SP/TR Sign Bench, surface mount, red powder coated frames, 8 ft. long, red thermo-plastic coated contour seat. Shown without standard seat dividers.



Model B400/CN-6SP/TN Sign Bench, surface mount, green powder coated frames, 6 ft. long, green thermo-plastic coated contour seat.



Model B400/CB-6SP/TB surface mount, black powder coated frames, 6 ft. long, black thermo-plastic coated contour seat.





▲ Top cap opens for total access to the sign frame. Cap can be padlocked closed.



◀ The sign board slides in front of the back support. Your sign can be replaced as often as you want.



▶ The back support slides in and out of the sign frame. (Note: board is not painted to better show detail.)

Contour Seating	Model Number Insert Model Number prefix for bench style choice	Length (ft.)	Seat Dividers	Seat Material and Finish	Frame Finish	Sign Size H x W
MODEL B400 SURFACE MOUNT 	B400/CB-4SP/TB	4	0	Cut 10 ga. steel plate seat and sign frame. Thermo-plastic coated black (/TB) is standard. Other colors available. <i>See Page 55.</i>	Powder coated black(/CB) is standard. Other colors available. <i>See Page 52.</i>	24" x 48"
	___/CB-6SP/TB	6	2			24" x 72"
MODEL B401 EMBEDDED MOUNT 	___/CB-8SP/TB	8	3			24" x 96"



Model B410/G-8VR portable/surface mount, hot dip galvanized frames, 8 ft. long, expanded steel seat, red thermo-plastic coated seat and sign frame.

SIGN BENCH - B410 Series Classic Seating

- All steel fabrication: steel sign frame, expanded steel or perforated steel or steel channel seat. Seat is 2-1/2 in. x 12 in. wide (nom.).
- Thermo-plastic seat coating in your choice of colors.
See Pages 55-57.
- Frame legs are 2-3/8 in. OD steel pipe, with formed channel seat and back support.
- Installation options: Embedded frame post, portable/surface mount, or bolt down base plate mount.
(Anchors not included, see Page 126).
- Hot dip galvanized or powder coat frame finish.
See Pages 52.
- **Optional:** 2-part aluminum cover caps for B411 and B412 frame posts. *See Page 26.*

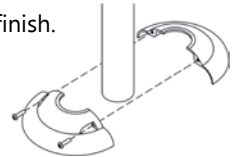

BOTH SIGN BENCH MODELS OFFER:

- Black painted 3/4 in. MDO Sign Board back support for sign.
- **Optional:** Custom made Pilot Rock Sign features: .040 ga. Alumilite aluminum laminate, 1/4 in. thick, polycarbonate core, a 3M vinyl digitally printed graphic material, a 3M protective lamination over the graphic.
- Order/reorder signage from Pilot Rock Signs or your local sign company (use max. 1/4 in. thick material).
- Sign graphic can be replaced as often as you want. Just open the top cap and slide it out.
- Hinged top cap closes the sign frame and can be padlocked to secure the sign (padlocks not included — order (2) #PL-1). The sign cannot be removed when cap is closed.



Model B410/G-4VU Sign Bench, portable/surface mount, hot dip galvanized frames, 4 ft. long, blue thermo-plastic coated expanded steel seat and custom 'Buddy Bench' themed sign.



1 The back support slides in or out of the sign frame. (Note: board is not painted to better show detail.) Top cap is shown open.



2 The top cap is hinged at both ends and easily lifts up and tips behind the bench. It's easy to install or replace your sign.



3 The top cap can be padlocked in the closed position to secure your sign until you want to replace it.

Classic Seating	Model Number Insert Model Number prefix for bench style choice	Length (ft.)	Seat Material and Finish	Frame Finish	Sign Size H x W
MODEL B410 SURFACE MOUNT 	B410/G-4VB	4	Black thermo-plastic coated expanded steel (VB) Other colors available. <i>See Page 56.</i>	Hot dip galvanized finish (/G), or Black powder coat finish (/CB). Other colors available. <i>See Page 52.</i>	16" x 48"
	___/G-6VB	6			16" x 72"
	___/G-8VB	8			16" x 96"
MODEL B411 EMBEDDED MOUNT 	___/G-4HB	4	Black thermo-plastic coated perforated steel (HB) Other colors available. <i>See Page 57.</i>		16" x 48"
	___/G-6HB	6			16" x 72"
	___/G-8HB	8			16" x 96"
MODEL B412 BOLT-DOWN MOUNT 	___/G-6SC/TB	6	Black thermo-plastic coated formed steel channel (SC/TB) Other colors available. <i>See Page 55.</i>	16" x 72"	
	___/G-8SC/TB	8		16" x 96"	

With custom signage you can recognize memorials, donations, service, special occasions, ownership, schools and teams, anybody or anything you want, promote a service organization, and prevent theft. Message size limits vary by application. Contact us for custom design pricing.

Metal Plaques



- Silver or bronze colored border and raised letters.
 - Background color is baked on. Choice of 4 colors: black, brown, maroon, green.
 - Lightly textured, durable, lightweight, and resistant to the elements and wear.
 - Two shapes: **Rectangular** (2-1/2" h. x 11-3/4" w.) Available on most benches using wood or plastic.
 - **Round** (6" diameter) Available on B78, B79, B82, B94, B102, B122 and B123 steel strap and cut steel plate contour benches.
- Some custom colors may be available. Please inquire.*

Laminate Plaques

- Made from laminated impact acrylic. 3 ply thickness (1/8"). Plaques can be recessed (on wood and plastic only), or surface applied (on wood, plastic, steel, and aluminum). For picnic table tops, recessed plaques are available on recycled plastic only and require full edge caulking.
- Plaques are up to 2-1/2" x 11-3/4" wide.
- Rated for exterior usage, UV stable and outdoor weatherable. Matte finish, non-glare, contrasting surface and core colors.
- Surface/core color combinations include: matte black/gold, gloss black/white, white/crimson, patriot blue/white, almond/black, kelly green/white. Other colors may be available, please inquire.

Plaque is surface applied on a steel bench.



Plaque is recessed into plastic planks.

Put your custom message in color or personalize your plaque with a photo!



Engraved Lettering



- Engraved letters are available on benches, tables, and trash receptacles using recycled plastic.
- Letters can be filled with a colorful resin to increase visibility.
- Resin fill is durable, weather resistant, color-fast. Many colors available.



Perforated Steel and Cut Steel Signage



- Perforated 2" x 12" steel benches (not contour), tables and receptacles can have custom lettering included. Number and size of letters limited.
- Benches with cut steel plate seats can include a custom cut design.



Matching Trash Receptacles and Planters

A useful complement to your public seating is a trash receptacle . . . we have many designs to match your bench!

See pages 59-67



Enhance your public area with planters that match your bench!

See page 87.

Armrests

Armrests are available on selected benches and sold individually.

Benches	B78, B79	PCXB, SCXB			PCXB, SCXB	PWRB, SWRB, OWRB	WB, OWB	B94
Model #	AR/C♦-13	AR/T♦-2	AR/T♦-7	AR/T♦-9	AR/♦-1	AR/♦-4	AR/♦-6	AR/C♦-10
Bench Seat Material	Expanded or Perforated Steel	2-1/2" x 10" or 2-1/2" x 12" Perforated Steel	2-1/2" x 10" Expanded Steel	2-1/2" x 12" Expanded Steel	Wood or Recycled Plastic 2" x 4" or 2" x 10" planks	Wood or Recycled Plastic 3" x 4" timbers	Wood or Recycled Plastic 3" x 4" timbers	
Location	Center	End or Center			End or Center			Center
Armrest Material and color	2-3/8" OD steel Pipe /C♦ Indicates color of powder coated finish. Color matches frames. See Page 52.	3/16" x 2" steel /T♦ Indicates color of thermo-plastic coating. Color matches seat. See Page 56-57.			3/16" x 2" galvanized steel (/G) Optional: Powder coat finish, /C♦ Indicates color of powder coated finish. Color matches frame. Armrest pad matches seat material. See Page 52.			Cast Iron /C♦ Indicates color of powder coated finish. Color matches seat. See Page 52.

Cover Caps

- Two-part Cover Caps for Park Benches, Picnic Tables, Bike Racks and More.
- Each half is cast aluminum, with no coating. Requires 5/32-inch hex key (Allen wrench) to assemble (not included). Fasteners included.
- 2-1/2 inch diameter center hole will fit all 2-3/8" OD frame posts. 8-inch outside diameter.
- Available with aluminum finish to match galvanized frame posts. Or can be powder coated to match the painted frame finish.
- Cover Caps are not available on products finished with thermo-plastic coating.
- Order (1) Model CC-1 cover cap (2 halves) for each frame post.

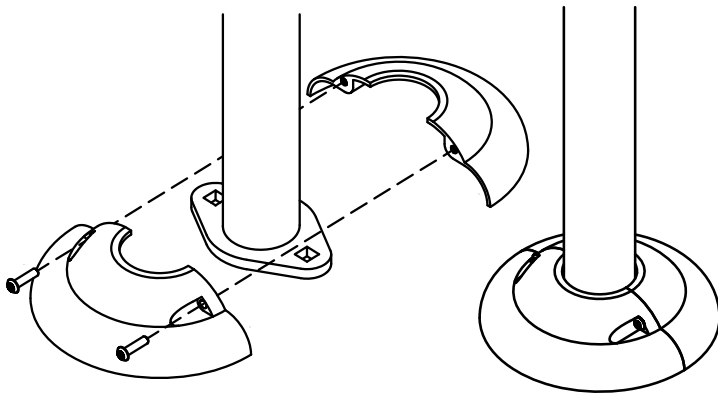

Model CC-1 two-part Cover Cap can be an Optional Accessory on These Products	
Benches	B400, B401, B411 and B412 Sign Bench; SCXB and SCXB/P Channel Bench; B121 and B123 Contemporary Bench; B111C Accessible Bench; B41 and B43 Silver Sioux Bench; B60, B61, B62, B63, B76, B77, B78 and B79 Riverview Bench; SAB and SAB/P Athletic Bench.
Picnic Table	T600 Caterpillar Table, FCT Food Court Table
Trash Receptacles	CN-TR-52 Tilting Trash Receptacle (embedded post); M2 and M8 Receptacle Mounting Post .
Bike Racks	HRE and HRP Hitching Post Rack; SRE and SRP Saddle Back Rack.
Lantern Poles	LH-1, LH-2 and LH-180 Poles.
Charcoal Grills	ASWS-20 B6S, ASWS-24 B6S, J-20 B6, NS-20 B6S, H-16 B6, H-16 B6X2, and GS-5



Benches are often included in outdoor 'smoking-permitted' areas. Don't forget about an ash receptacle to dispose of smoking waste. See page 74.

Coordinate Products for the look you want!

Tables, Benches and Trash Receptacles can be coordinated by selecting matching materials... lumber, aluminum, recycled plastic, thermo-plastic coated expanded, perforated or formed steel plate, and the frame finish... and by selecting matching or complimentary colors. See Pages 52-57.

Increase company, organization, school, or sports team visibility by coordinating colors and adding custom signage to benches, tables, and receptacles. See Pages 24-25.



Pilot Rock
PARK · STREET · CAMP
SITE PRODUCTS



**Pilot Rock® Products are
Designed & Manufactured
in the USA - Since 1959**

HEAVY DUTY TABLE - UT Series

- **Model UT** Tables are designed for most public applications. Built rugged, but with less weight, easier to move.
- Model UT Tables feature our nontip, nontrip, walk through design. Won't tip even if all persons sit on one side. Easy walk through access. "Skid" design permits movement without damage to turf.
- All welded 1-5/8" OD steel pipe end frames (1.660" OD, 11 ga. wall, 1-1/4" ID nom. pipe specifications). Top/seat mounting brackets are 2" x 2" x 10 ga. die-formed steel angles.
- Frames supported by diagonal braces of 1-5/16" OD steel pipe attached to steel center channel. All 3/8" dia. galvanized carriage bolt fasteners. **Lifetime warranty.** See Page 129.
- **Standard finish:** Hot dip galvanized after fabrication.
- **Optional frame finish:** Powder coating (in place of galvanized finish). See Page 52 for colors.
- Model UT Tables offer 30" nom. table height; 18" nom. seat height.

Available Materials. See Pages 52-57	Lengths (feet)
2x10 Untreated or Pressure Treated Pine	6, 8, 10, 12
Aluminum	6, 8, 10, 12
2x10 100% Recycled Plastic	6, 8, 10
Thermo-plastic coated Expanded Steel (<i>D-type only</i>) or Perforated Steel (<i>R-type only</i>)	6, 8, 10
Formed Steel Channel	6, 8

- Wheelchair Accessible Table Designs available: end access, side access, and raised top with end access. See Pages 30 & 47.
- Childrens Size Table with dimensions to fit children and their activities. See Page 31.



Model UT/G-12AL, galvanized frames, 12 ft., clear anodized aluminum.



Model UT/CN-6UP, green powder coated frames, 6 ft., untreated pine lumber.



Model UT/G-8RW, galvanized frames, 8 ft., thermo-plastic coated perforated steel in brown.



Model UT/G-6SC/TO, galvanized frames, 6 ft., formed steel channel top and seats, orange thermo-plastic coated finish.

EXTRA HEAVY DUTY TABLE - XT Series

- **Model XT** Tables designed and constructed specifically for heavy use areas where unusually difficult service may be required.
- Model XT Tables feature our nontip, nontrip, walk through design. Won't tip even if all persons sit on one side. Easy walk through access. "Skid" design permits movement without damage to turf.
- All welded 2-3/8" OD steel pipe end frames (2.375" OD, 11 ga. wall, 2" ID nom. pipe specifications). Top/seat mounting brackets are 2" x 2" x 10 ga. die-formed steel angles.
- Frames supported by diagonal braces of 1-5/16" OD steel pipe attached to steel center channel. All 3/8" dia. galvanized carriage bolt fasteners. **Lifetime warranty.** See Page 129.
- **Standard finish:** Hot dip galvanized after fabrication.
- **Optional frame finish:** Powder coating available (in place of galvanized finish). See Page 52 for colors.
- Model XT Tables offer 30" nom. table height; 18" nom. seat height.



Model XT/G-6UP, galvanized frames, 6 ft., untreated pine lumber.

Available Materials. See Pages 52-57	Lengths (feet)
2x10 Untreated or Pressure Treated Pine	6, 8, 10, 12
Aluminum	6, 8, 10, 12
2x10 100% Recycled Plastic	6, 8, 10
Thermo-plastic coated Expanded Steel or Perforated Steel	6, 8, 10
Formed Steel Channel	6, 8

- Wheelchair Accessible Table Designs available: End access, side access, and raised top with end access. See Pages 30 & 47.

SNOW LOAD RATED OPTION
When equipped with V-Type expanded steel or H-Type perforated steel top/seats. See Page 46.



Model XT/CB-8AR, 8 ft. long, black powder coated frames, red powder coated aluminum top and seats.



Model XT/G-8VN, galvanized frames, 8 ft., thermo-plastic coated expanded steel in green.



Model XT/G-6PU, galvanized frames, 6 ft., 100% recycled plastic in blue color.



ACCESSIBLE TABLES - UT & XT Series

End Accessible Tables

- **Models UT** (1-5/8" OD) and **XT** (2-3/8" OD) **standard height** table frames. See Pages 28-29. Under table clearance of 28". Tables offer 30" nom. table height; 18" nom. seat height.
- **Models UTH** (1-5/8" OD) and **XTH** (2-3/8" OD) **raised height** table frames are designed to provide more clearance under the table top to allow most wheelchair armrests to fit under it for a closer approach. Higher frames provide an under table clearance of 31". Tables provide 33" nom. table top height; 19" nom. seat height. See Pages 28-29.
- Both models meet or exceed ADA guidelines for wheelchair access to picnic tables. See Page 47.
- Top is extended beyond seats on one or both ends to provide ADA approved wheelchair access.
- Models /E or /EE extended top are supported by a special diagonal brace and steel channel.
- Outriggers are included (on certain models) to add increased stability.



(above) **Model UT/G-6SC/TR/E**
1-5/8" OD galvanized frames, 6 ft. seats, 8 ft. top extended 2 ft. one end, formed steel channel thermo-coated in red.



(left) **Model UTH/G-6DU/E**
1-5/8" OD galvanized frames, 6 ft. seats, 8 ft. top is raised and extended 2 ft. one end, thermo-plastic coated expanded steel in blue.

Side Accessible Tables

- **Models UT** (1-5/8" OD) and **XT** (2-3/8" OD) Side Access Tables (/SA) take out a section of seating along side of table to provide wheelchair access right in the middle of activities. Tables offer 30" nom. table height; 18" nom. seat height.
- Meets or exceeds ADA guidelines for wheelchair access to picnic tables. See Page 47. Nominal under table clearance of 28 in., nominal seat height is 18 in.
- 6 ft. and 8 ft. tables provide one side opening. Two one-person seats are located on either side of wheelchair.
- 10 and 12 ft. tables feature two locations for wheelchairs, diagonally opposite each other. ADA guidelines require two wheelchair spaces on these larger tables. Each side includes a shorter one-person seat plus a longer seat to fit 3-4 persons.
- Diagonal braces are used to support and reinforce the table structure. Brace positioning allows wheelchair spaces to meet ADA clearance guidelines.



Model XT/G-6AL/SA 2-3/8" OD galvanized frames, 6 ft., clear anodized aluminum, side access opening for one wheelchair.

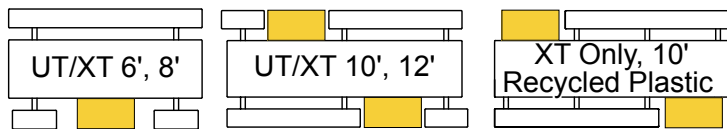

Wheelchair Accessible Design	Model Series	End Accessible Tables - Available materials when top is extended					Side Accessible Tables
		2 ft. at ONE end = /E 6' seats, 8' top	2 ft. at ONE end = /E 8' seats, 10' top	2 ft. at BOTH ends = /EE 6' seats, 10' top	1 ft. at BOTH ends = /E1 6' seats, 8' top	1 ft. at BOTH ends = /E1 8' seats, 10' top	
End Accessible Standard Height	UT XT	All Materials	Lumber Aluminum Recycled Plastic	Lumber Aluminum	All Materials	Lumber Aluminum	
End Accessible Raised Top/Seats	UTH XTH						
Side Accessible Standard Height	UT XT						Lumber Aluminum Recycled Plastic*

*12' not available w/ recycled plastic

KID'S TABLES —

Rectangular, Square and Round

- Tables are proportionally scaled to fit children up to 10 - 11 yrs old.
- Seats are 12" high. Top is 22" high.
- Frame fabrication and top/seal construction are identical to the standard size tables. All welded construction with appropriate bracing and supports. Children can be hard on furniture. You need outdoor picnic tables built to take it.
- See pages 52-57 for material and finish choices



Model UTK/G-8RU
galvanized frames,
8 ft., blue thermo-plastic
coated perforated steel
top and seats.

RECTANGULAR TABLE – Model UTK

- UTK Tables are built to same specifications as UT Tables. See Page 28.
- **Standard frame finish:** Hot dip galvanized after fabrication.
- **Optional frame finish:** Powder coating.
- Top/seal materials:

Available Materials. See Pages 52-57	Lengths (feet)
2x10 Untreated or Pressure Treated Pine	4, 6, 8
Aluminum	4, 6, 8
2x10 100% Recycled Plastic	4, 6, 8
Thermo-plastic coated Expanded Steel or Perforated Steel	6, 8
Thermo-plastic coated formed Steel Channel	6, 8



Model UTK/G-4UP galvanized frames, 4 ft., untreated pine lumber.

SQUARE TABLE – Model SQTK

- SQTK Tables provide a 48" square top and 4 bench seats. Built to same specifications as SQT-4 Tables. See Page 38.
- **Standard frame finish:** Hot dip galvanized after fabrication.
- **Optional frame finish:** Powder coating.
- Top/seal materials:

Available Materials. See Pages 52-57	Size (inches)
2x10 Untreated or Pressure Treated Pine	48
Aluminum	48
2x10 100% Recycled Plastic	48
Thermo-plastic coated Expanded Steel or Perforated Steel	48



Model SQTK/CW-4PY brown powder coated frames, 4 ft., yellow recycled plastic planks.

ROUND TABLE – Model T104K

- T104K Tables provide a 48" round top and 4 curved seats. Built to same specifications as T100 Tables. See Page 40.
- **Standard frame finish:** Hot dip galvanized after fabrication.
- **Optional frame finish:** Powder coating.
- Top/seal materials:

Available Materials. See Pages 54-57	Size (inches)
100% Recycled Plastic	48
Thermo-plastic coated Expanded Steel or Perforated Steel	48



Model T104K/CY-4DR yellow powder coated frames, 4 ft., red thermo-plastic coated expanded steel top and seats.



UNIVERSAL ACCESS TABLE - WXT & WXTH Series

- **Model WXT** Tables provide ADA compliant wheelchair access at both ends.
- Full length seats offer full capacity seating
- Unique frame design includes two wheelchair spaces plus provides proper support under the outside ends of the full length seats.
- Meets or exceeds ADA guidelines for wheelchair access to picnic tables. See Page 47. Nominal under table clearance of 28 in., nominal seat height is 18 in.
- **Lifetime frame warranty.** See Page 129.
- Model WXT frames are constructed of 2-3/8" OD steel pipe, welded into a single piece structure for strength and easy assembly.
- Unique patented transverse frame leg under seat makes this a very stable table.
- Frame finish: Hot dip galvanized or powder coated. See Page 52 for colors.
- **Model WXTH** Tables offer the same patented accessible design features of WXT Tables but with a raised table top, allowing most wheelchair armrests to fit under it for a closer approach.
- Model WXTH tables exceed ADA guidelines for wheelchair access to picnic tables. See Page 47. Nominal under table clearance of 31 in., nominal seat height is 19".



Model WXTH/G-6UP, galvanized frames, 6 ft., untreated pine lumber.

Available Materials. See Pages 52-57	Lengths (feet)
2x10 Untreated or Pressure Treated Pine	6, 8, 10, 12
Aluminum	6, 8, 10, 12
2x10 100% Recycled Plastic	6, 8
Thermo-plastic coated Expanded Steel or Perforated Steel	6, 8, 10
Formed Steel Channel	6, 8



SNOW LOAD RATED OPTION

When equipped with V-Type expanded steel or H-Type perforated steel top/seats. See Page 46.



WXT/G-8DR galvanized frames, 8 ft. long, expanded steel with blue thermo-plastic coating.



Model WXT/CN-8PW, green powder coated frames, 8 ft., 100% recycled plastic top and seats in brown color.

U.S. PATENT NOS. D489,539; D490,992; D493,291;
D496,799; D497,262; 6,918,630



Model WXT/G-6AL galvanized frames, 6 ft., clear anodized aluminum top/seats (Note: because of lighter weight of this 6 ft. table with aluminum, the seats are nominally shorter than top to improve stability).

UNIVERSAL ACCESS TABLE - WPTS Series



- **Model WPTS** Tables offer all the same accessible design features of the WXT Series Tables, but with a square frame. *See Page 32.*
- Accessible to wheelchairs at both ends plus full length seats for maximum capacity seating.
- Available lengths: 6 or 8 ft.
- **Model WPTS** provides ADA compliant wheelchair access at both ends. Nominal under table clearance of 29 in., nom. seat height is 18 in. *See Page 47.*
- **Frames:** welded 3" x 6" (nom.) 1/8" wall rectangular steel tube for top and seat supports, connected with 2-1/2" (nom.) x 1/8" wall square steel tube.
- **Frame Finishes:** Hot dip galvanized or powder coated. *See Page 52.*



Model WPTS/G-8VW, galvanized frames, 8 ft., thermo-plastic coated expanded steel with brown color.



SNOW LOAD RATED OPTION
When equipped with V-Type expanded steel or H-Type perforated steel top/seats. *See Page 46.*



Model WPTS/CB-8PW, black powder coated frames, 8 ft., 100% recycled plastic top and seats in brown color.

Available Materials. See Pages 52-57	Lengths (feet)
2x10 Untreated or Pressure Treated Pine	6, 8
Aluminum	6, 8
2x10 100% Recycled Plastic	6, 8
Thermo-plastic coated Expanded Steel or Perforated Steel	6, 8
Formed Steel Channel	6, 8

U.S. PATENT NOS. D489,539; D490,992; D493,291; D496,799; D497,262; 6,918,630



T720/CB-6DW black powder coated frames, 6 ft. long, expanded steel with brown thermo-plastic coated top and seats.

CUSTOM IDENTITY TABLE - T720 Series

- **Model T720** Tables include your custom identity on each vertical support panel.
- Each frame is fabricated using 2-1/2 x 2-1/2 in. x 1/8 in. wall sq. tube for the base and seat supports; 10 ga. steel plate for the vertical support panel and the top/seat mounting angles. All welded fabrication. Table assembly includes two 1-5/16" OD steel tube diagonal braces.
- Each frame base includes (2) 9/16 in. dia. anchor bolt holes (anchor bolts not included).
- **Frame finish:** Hot dip galvanized, or powder coated in your color choice. *See Page 52.*
- Available lengths: 6 or 8 ft.
- **Wheelchair Accessible:** 6 ft. long seats with 8 ft. long top extended one foot at each end (/E1) will provide ADA compliant wheelchair access at both ends.



• **Custom Identity:** Each T720 Table includes your custom identity laser cut into the steel vertical support on each frame. Use this space for your agency name, school or team name, or other message (design and space limitations apply – we will send you proof for approval prior to making your table).

• **Optional:** Surface mount anchor kit #ANC2-4. Use one kit per table. *See page 126.*



Available Materials. See Pages 52-57	Lengths (feet)
2x10 Untreated or Pressure Treated Pine	6, 8
Aluminum	6, 8
2x10 100% Recycled Plastic	6, 8
Thermo-plastic coated Expanded Steel or Perforated Steel	6, 8
Formed Steel Channel	6, 8

A-FRAME WOOD TABLE - AFT Series



Model AFT-6TP all wood, 6 ft., A-frame table, treated pine lumber.

- **Model AFT** is your traditional ALL WOOD A-frame style picnic table. All components are pressure treated #1 southern yellow pine (*nom. dimensions*):
 - 4" x 6" leg posts
 - 2" x 4" and 2" x 6" connecting and support braces
 - 2" x 10" top/seat planks
- Model AFT frames are assembled using 3/8" dia. carriage bolts for superior clamping force to keep the table solid. Top/seat planks are secured with stainless steel screws. All lumber is precision drilled to facilitate assembly. All fasteners are included.
- Dimensions: 6 ft. or 8 ft. long, 30-1/4" table height, 17-3/4" seat height (*nominal*).



Model AFT-8TP, all wood, 8 ft. long, A-frame table, treated pine lumber, wheelchair accessible at both ends.



- The 8 ft. long table is wheelchair accessible and provides ADA compliant wheelchair access points at both ends. See Page 47.

A-FRAME PLASTIC TABLE - AFT Series

- **Model AFT** is your traditional ALL PLASTIC A-frame style picnic table. All components and bracing are 100% recycled plastic (*nom. dimensions*):
 - 4" x 6" leg posts
 - 2" x 4" and 2" x 6" connecting and support braces
 - 2" x 10" top/seat planks
- Standard Colors: Brown or black leg posts and braces, and Cedar color top/seat planks. Other plank colors are available. See Page 54.
- Model AFT frames are assembled using 3/8" dia. carriage bolts for superior clamping force to keep the table solid. Top/seat planks are secured with stainless steel screws. All plastic lumber is precision drilled to facilitate assembly. All fasteners are included.
- Dimensions: 6 ft. or 8 ft. long, 30-1/4" table height, 17-3/4" seat height (*nominal*).
- The 8 ft. long table is wheelchair accessible and provides ADA compliant wheelchair access points at both ends. See Page 47.



Model AFT/B-6PC all plastic, 6 ft. long, black frames, cedar colored top/seat planks.



Model AFT/W-8PW all plastic, 8 ft. long, A-frame table with brown recycled plastic seats, top, and frames

A-FRAME TABLE - AT Series

- A traditional table modified to withstand public and commercial use.
- Model AT Tables incorporate pre-galvanized steel braces and cross supports for a stronger A-frame design.
- Frames are supported by diagonal braces of 1-5/16" OD galvanized steel pipe attached to a steel center channel under the table top. All 3/8" dia. galvanized carriage bolts (not lag screws) are provided for assembly.
- Model AT Tables use 4" x 6" (nom.) leg posts, and 2" x 10" (nom.) top/seat planks. Choose either pressure treated #1 southern yellow pine, or 100% recycled plastic. *See Pages 53-54.*
- 6 ft. or 8 ft. long (2 frames) using lumber or recycled plastic; 12 ft. long (3 frames) using treated pine only.
- **Wheelchair Accessible:** 6 ft. long seats with 8 ft. long top extended 1 ft. at each end provides ADA compliant wheelchair access at both ends. *See Page 47.*
- **Snow Load Rated Table:** Model WAT-8, available only with recycled plastic, includes additional steel braces under the seats and top to provide a Snow Load Rating of 500 lbs. per sq. foot. Model WAT-8 is also wheelchair accessible at both ends providing ADA compliant knee and toe clearances. *See Page 47.*
- **Optional:** Subframe support structure on Model AT and WAT-8 tables can be fabricated from steel and powder coated in your choice of colors. *See Page 52 for colors.*



(Top) **Model AT-6TP** 6 ft., pressure treated pine lumber.
(Right) **Model AT/W-6PN/E1** 6 ft. seats, 8 ft. top extended 1 ft. at both ends for two wheelchair access points, recycled plastic brown leg posts, green top/seat planks.



 **SNOW LOAD RATED OPTION**
When equipped with additional bracing on top and seats. *See Page 46.*

Model WAT/W-8PW 8 ft. seats and top, wheelchair access at both ends, brown recycled plastic.

Enjoy the Outdoors — with a complete set of site furnishings.



CATERPILLAR TABLE - T600 Series

- The elevated, open span frame design of our Model T600 Park Table creates a clear area under and around the table for easier clean up. Surface mount (bolt down) installation (includes a set of anchors. See Page 126.)

- All tables are ADA compliant for wheelchair access at both ends.

- The frame legs are 2-3/8" OD (2.375" OD, 11 ga. wall, 2" ID nom.) steel pipe formed and welded into single units. Seat support brackets are 10 ga. welded steel plate.

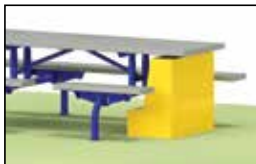

- Standard finish: Hot dip galvanized.

- Optional:** Powder coat frame finish. See Page 52 for colors.

- Optional:** 2-part aluminum cover caps for T600 table frame posts. See page 50.

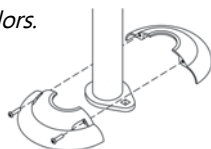

- Model T600 Table configurations include:

- Model T602-6:** 6 ft., 2 full length seats, step-over entry.
- Model T602-8:** 8 ft., 2 full length seats, step over entry.
- Model T603-8:** 8 ft., 1 full length seat, and two short seats, walk in entry.
- Model T604-8:** 8 ft., 4 short seats, walk in entry.
- Model T602-10:** 10 ft., 2 full length seats, step over entry.
- Model T604-10:** 10 ft., 1 full length seat, and three short seats, walk in entry.
- Model T606-10:** 10 ft., 6 short seats, walk in entry.

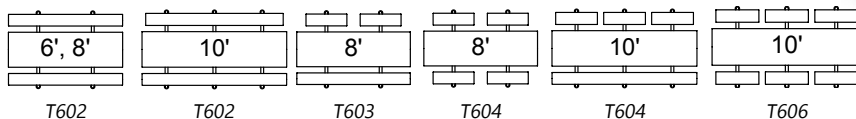

Model T604/G-8TP table, 4 walk-in seats, 8 ft., treated pine.

Available Materials. See Pages 52-57	Lengths (feet)
2x10 Untreated or Pressure Treated Pine	6, 8, 10
Aluminum	6, 8, 10
Thermo-plastic coated D-Type Expanded Steel or R-Type Perforated Steel	6, 8, 10
Formed Steel Channel	6, 8



Model T603/G-8DN surface mount table, one long seat, two short seats (total 3 seats), hot dip galvanized frame, 8 ft., thermo-plastic coated expanded steel in green color.

LIGHT DUTY TABLE - BT Series

- Model BT** Tables combine pre-galvanized steel tube frames with the economy of a bolt together design.

- Model BT Tables feature our nontip, nontrip, walk through design. Won't tip even if all persons sit on one side. Easy walk through access. "Skid" design permits movement without damage to turf.

- Frame features: Pre-galvanized steel top/seat mounting angles, two diagonal braces of 1-5/16" OD pre-galvanized steel tube, 3/8" dia. galvanized carriage bolt fasteners.

- BT Table Frames come in two sizes:

BTUG Series

- Fabricated using 1-5/8" OD x 12 ga. steel tube end frames.
- Model BTUG tables can be 4, 6 or 8 ft. long.
- Table offers 28" nom. table height; 17" nom. seat height.

BTXG Series

- Fabricated using 2-3/8" OD x 12 ga. steel tube end frames.
- Model BTXG tables can be 6 or 8 ft. long.
- Table offers 29" nom. table height; 18" nom. seat height.

- Top/seat materials available: 2" x 10" untreated or pressure treated #1 southern yellow pine or aluminum (see Pages 53-54.)



Model BTXG-8AL, 8 ft., clear anodized aluminum.



Model BTUG-6UP, 6 ft., untreated pine lumber.

RECYCLED PLASTIC TABLE - RT Series

- **Model RT** Tables feature components molded from 100% recycled plastic.
 - Frames are 3" thick single-piece, available in Brown, Black or Green colors. *(Other colors may be available as a special order)*
 - 2" x 10" (nom.) top/seat planks are available in many colors. *See Page 54.*
- Top/seat mounting angles are formed from pre-galvanized steel. The table structure is reinforced with diagonal braces of 1-5/16" OD pre-galvanized steel tube. These steel components add strength. All 3/8" dia. galvanized carriage bolt fasteners are included.
- RT Tables available in 6 and 8 ft. lengths.
- **Wheelchair Accessible**
 - **/E Option:** 8 ft. top extends 2 ft. beyond 6 ft. seats at one end provides ADA compliant wheelchair access. Extended top is supported by a diagonal brace. *See Page 47.*
 - **/E1 Option:** 8 ft. top extends 1 ft. beyond 6 ft. seats at each end provides ADA compliant wheelchair access. *See Page 47.*
- Model RT Tables feature our nontip, nontrip, walk through design. Won't tip even if all persons sit on one side. Easy walk through access. "Skid" design permits easier movement. Tables offer 30" nom. table height; 17-1/2" nom. seat height.



Model RT/N-6C 6 ft., green frames, cedar colored top/seat planks.



Model RT/W-6C/E brown frames, cedar colored top/seat planks, 6 ft. seats, 8 ft. top extended at one end to provide wheelchair access.



Model ART/B-8C, black frames, 8 ft. long, cedar colored top and seat planks.

RECYCLED PLASTIC TABLE - ART Series

- **Model ART** Tables feature components molded from 100% recycled plastic.
 - Frames are 3" thick single-piece with classic arch design, can be Black or Brown.
 - 2" x 6" (nom.) top/seat planks are available in many colors. *See Page 54.*
- Table design uses three step-over style frames for support so no additional steel braces are necessary. Includes stainless steel screws for assembly.
- Model ART is available in 2 standard sizes: 6 ft. and 8 ft. long.
- Model ART nominal dimensions: 17-1/2" seat height, 30-1/2" table top height. Non tip step over table frames, table won't tip even if all persons sit on one side.
- Model ART is also offered in an ADA compliant design with 6 ft. seats and 8 ft. top extended 1 ft. at each end to provide two wheelchair access points. This configuration provides the ADA recommended under table clearances. *See Page 47.* Plastic end caps are blue on table top.



Model ART/W-6N/E1 brown frames, green top and seat planks, 6 ft. seats, 8 ft. top extended at both ends to provide wheelchair access at both ends.

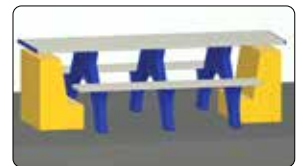

PORTABLE SQUARE TABLE - SQT Series

- **Model SQT** Tables offer portability plus a square seating pattern that fully utilizes the table top: an ideal game or craft table.
- Model SQT Tables come in two sizes:
 - SQT-3** has 38" sq. top
 - SQT-4** has 48" sq. top.
 Each table includes 4 flat bench seats. The frame design includes our nontip, nontrip, walk-through features. Tables offer 30" nom. table height; 18" nom. seat height.
- Corner frames are fabricated from 1-1/2" OD x 12 ga." wall structural steel pipe; 1-3/4" x 1-3/4" x 10 ga." thick steel top/seat mounting angles; 1-5/16" OD cross braces.
- Standard frame finish: Hot dip galvanized after fabrication.
- **Optional:** Powder coat frame finish. *See Page 52 for colors.*

Available Materials. See Pages 52-57	Size (inches)
2x10 Untreated or Pressure Treated Pine	38, 48
Aluminum	38, 48
2x10 100% Recycled Plastic	38, 48
Thermo-plastic coated Expanded Steel or Perforated Steel	48

- **Wheelchair Accessible:** Model **SQT-4** is available with one seat structure eliminated and the top extended to create a wheelchair accessible space. This table variation is available with lumber or 100% recycled plastic planks, thermo-plastic coated expanded or perforated steel.



Model SQTB3/G-4R0 galvanized frames, 48" sq. top, orange thermo-plastic coated perforated steel top and seats, one seat eliminated and top extended to provide wheelchair access.

- **Optional:** Game Board Table Top (*See Page 50*) available on SQT-4 tables with thermo-plastic coated expanded or perforated steel. The Game Board insert is 14 ga. steel powder coated black. After the vinyl game decal is applied the insert is sealed with a clear coat finish. The standard game decal is a red/black checkerboard.



(Above) **Model SQT/G-4VN** galvanized frames, 48" sq. top, green thermo-plastic coated expanded steel top and seats, optional umbrella.

- **Optional:** Umbrella hole/cup/collar to accommodate your choice of umbrellas with 1-1/2" diameter poles. *See Page 48.* (This hardware is included on thermo-plastic coated tables.)
- **Optional:** Backrest attachments for the seats, available in all the same materials to match the seats/tops. *See Page 49.*
- **Optional:** 45" long contour bench seats are available on SQT-4 tables with thermo-plastic coated expanded or perforated steel. Replace the standard flat seat with 4 contour benches. (Model SQTB-4).
- **Childrens Size Table (Model SQTk)** available with dimensions to fit children and their activities. *See Page 31.*



Model SQT/G-3PC galvanized frames, 38" sq. top, 100% recycled plastic in cedar color.



Model PQT/G-4PU embedded post, galvanized frames, 48" sq. top, 100% recycled plastic in blue color. Shown with optional custom laminate plaque in center top plank.

SQUARE PEDESTAL TABLE - PQT Series

- **Model PQT** Pedestal Tables provide a secure, permanent location with the advantages of the square shape.
- Model PQT Tables come in two sizes:
 - PQT-3** has 38" sq. top
 - PQT-4** has 48" sq. top.
 Each table includes 4 flat bench seats. 32" table height, 20" seat height (nominal dimensions).
- Table is supported by one central, massive 5-3/8" sq. steel post. Embedded installation is standard. Each seat is supported by a 3-1/2" diameter steel tube, designed to resist lateral torsion and deflection. Single, central support post simplifies maintenance around table.
- Stationary installation prevents theft. Assembly points all fasteners to inside of central post so carriage bolt nuts are not exposed. Installation of top prevents access to inside of post.
- Standard frame finish: Hot dip galvanized after fabrication.
- **Optional:** Powder coat frame finish. See Page 52 for colors.

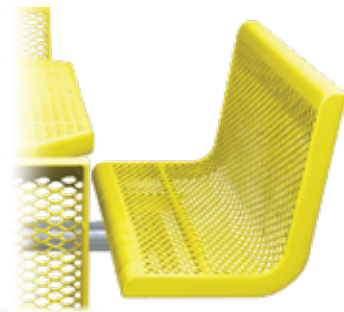

- **Optional:** 45" long contour bench seating is available on PQT-4 tables with thermo-plastic coated expanded or perforated steel. Replace the standard flat seat with 4 contour benches (Model PQT-4).

Available Materials. See Pages 52-57	Size (inches)
2x10 Untreated or Pressure Treated Pine	38, 48
Aluminum	38, 48
2x10 100% Recycled Plastic	38, 48
Thermo-plastic coated Expanded Steel or Perforated Steel	48



Model PQT/G-4AL embedded post, galvanized frames, 48" top, clear anodized aluminum.

- **Wheelchair Accessible:** Model **PQT-4** with 48" sq. top is easily adapted to meet ADA guidelines for wheelchair access. By removing one or more arm/seat structures the side of the table becomes accessible. 
- **Optional:** Frame post provided with 3/8" x 16" sq. steel bolt down base plate (anchor bolts not included). See Page 126.
- **Optional:** Umbrella hole/cup/collar to accommodate your choice of umbrellas with 1-1/2" diameter poles. See Page 48. (This hardware is included on thermo-plastic coated tables.)
- **Optional:** Game Board Table Top (See Page 50) available on PQT-4 tables with thermo-plastic coated expanded or perforated steel. The Game Board insert is 14 ga. steel powder coated black. After the vinyl game decal is applied the insert is sealed with a clear coat finish. The standard game decal is a red/black checkerboard. 



Model PQT/P/CB-3UP showing optional bolt down base plate installation, black powder coat frames, 38" top, untreated pine lumber.



Model PQT3/P/G-4PY one seat removed for wheelchair access, showing optional bolt down base plate installation, galvanized frames, 48" top, yellow 100% recycled plastic.

ROUND TABLES

- A perfect fit for... malls, patios, pools, decks, restaurants, rec centers, common areas, schools, golf courses, hotels, streetscapes, . . . any casual place where people gather.
- 48" diameter (nom.) round top with four seats.
- Frame finish: Hot dip galvanized or powder coated. *See Page 52.*



Model T104/CB-4RR portable table, black powder coated frames, 48" dia. round top, four curved seats, perforated steel coated with red thermo-plastic.

T200 Series Portable Table ▶

- Four seats with one frame support under each seat. A choice of 16" dia. (nom.) round seats to accommodate four people, or 10" x 40" (nom.) curved seats to accommodate up to eight people, or four chairs. *See Page 41.*
- 2-3/8" dia. steel pipe frame members bolt to a center hub.

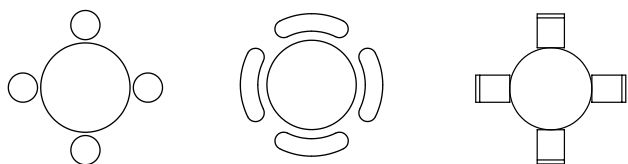

Model T404/G-4RW stationary table surface mount base plate, galvanized frames, 48" dia. round top, 4 curved seats, perforated steel coated with brown thermo-plastic.

- Top and seat material choices: (*See Pages 54-57*)
 - Thermo-plastic coated D-type expanded steel
 - Thermo-plastic coated R-type perforated steel
 - Thermo-plastic coated cut steel plate.
 - 100% recycled plastic top and seats.
- Umbrella hole in top and receiving cup on frame. Umbrella is optional. *See Page 48.*

◀ T100 Series Portable Table

- Four flat curved seats, 10" x 40" (nom.), enough seating for up to eight people, with two frame legs supporting each seat.
- 1-1/2" dia. welded steel pipe frame.
- **Optional:** Four contour bench seats. *See Page 41.*
- Childrens Size Table (**Model T104K**) available with dimensions to fit children and their activities. *See Page 31.*

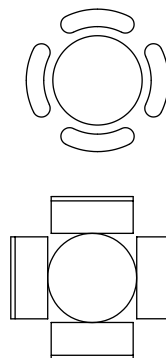

Model T214/G-4PC portable table, galvanized frames, 48" dia. round top, 4 round seats, with 100% recycled plastic in cedar color.

◀ T300 Series Embedded Post T400 Series Surface Mount

- Central support post is 5-3/8" sq. steel tube; seat support arms are 3-1/2" OD steel tube.
- Four 10" x 40" (nom.) flat curved seats provide seating for up to eight people, or four contour bench seats. *See Page 41.*
- Two choices of permanent theft-proof installation: Surface mount base plate (anchor bolts not included) or embedded post in concrete footing.
- Make the table wheelchair accessible by omitting one or more seats.

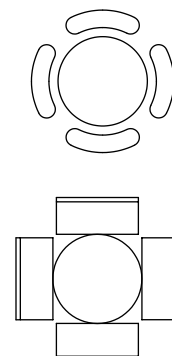



◀ Game Board Table Top

- Play your favorite game on this checkerboard style Game Board Table Top.
- Game Board is available on round tables with thermo-plastic coated expanded or perforated steel tops.
- Game Board insert is fabricated from 14 ga. steel, powder coated black. Includes automotive quality clear coat finish over red/black vinyl game decal and steel insert.

Model T204/G-4DW/GT portable table, hot dip galvanized frames, 48" dia. round top, four flat curved seats, expanded steel with brown thermo-plastic coating, optional game board top.

Chair Seat Available on T200 Series ▶

- Replace the flat curved or round seats on the T200 round table with individual chairs.
- The 16" wide chair is fabricated using 3/4-#9 expanded steel or 14 ga. perforated steel, with 1/4" thick side plates and 10 ga. and 7 ga. steel reinforcing with thermo-plastic coating to match the table top.



Model T224/G-4DW portable table, galvanized frames, 48" diameter round top, 4 chair seats, expanded steel coated with brown thermo-plastic.

Model T134/CB-4DA, portable table, black powder coat frames, 48" diameter round top, 4 contour expanded steel bench seats, coated with gray thermo-plastic.



◀ Bench Seat on T100, T300 and T400 Series

- Replace the flat curved seats on the T100, T300 or T400 round tables with contoured bench seats with room for two.
- The 45" wide seat is fabricated using 3/4-#9 expanded steel or 14 ga. perforated steel, with 1/4" thick side plates and 10 ga. and 7 ga. steel reinforcing.
- Each bench will be thermo-plastic coated to match the table top. See Pages 56-57 for color choices.

Cut Steel Plate Top and Seats ▶

- Available on all T Series Round Tables.
- 10 ga. cut steel plate makes an attractive top/seat design and a durable table structure.
- Thermo-plastic coat finish on top/seats. See Page 55 for color choices.
- Curved flat seats available on all models. Round seat available on T200 only.
- Wheelchair accessible tables are available using the T300 or T400 frames.



Model T204/G-4SP/TU portable table, galvanized frames, 48" diameter round top, 4 curved flat seats, cut steel thermo-plastic coated blue.

Model T104/G-4PC portable table, galvanized frames, 48" dia. round top, four curved flat seats, 100% recycled plastic in cedar color.



◀ 100% Recycled Plastic Top and Seats

- Curved flat seats: 10" x 40" (nom.) on T100, T300 and T400.
- Round seats: 16" dia. (nom.) on T200.
- 100% recycled plastic components, 2" thick. See Page 54 for colors.
- 2-piece top for easier handling and assembly. Includes umbrella hole.
- Wheelchair accessible tables are available using T300 or T400 frames.

MULTI-PEDESTAL TABLE - APT Series

- **Model APT** Multi-Pedestal Rectangular Tables provide a secure, permanent location. Stationary installation prevents theft. Table can be 6 or 8 ft. long with two full-length bench seats. 30" table height, 18" seat height (nominal dimensions).
- Provides a permanent location using two heavy pedestal posts of 3" x 6" x 1/8" wall rectangular steel tubing to support the table top and each seat. Exposed ends of frame posts are sealed with welded on end caps.
- Standard frame finish: Hot dip galvanized after fabrication.
- **Optional:** Powder coat frame finish. See Page 52 for colors.

Available Materials. See Pages 52-57	Lengths (feet)
2x10 Untreated or Pressure Treated Pine	6, 8
Aluminum	6, 8
2x10 or 3x4 100% Recycled Plastic	6, 8
Thermo-plastic coated Expanded Steel or Perforated Steel	6, 8
Formed Steel Channel	6, 8

- **Wheelchair Accessible:** Table may be provided with 8 ft. top, extending 1 ft. at each end beyond 6 ft. long seats to provide two wheelchair access points in accordance with ADA guidelines. See Page 47.
- **Optional:** All frame posts provided with 1/4" x 8" sq. steel bolt down base plate (anchor bolts not included). See Page 126.



Model APT/CB-6PC34/E1 embedded post installation, black powder coated frames, 3" x 4" cedar colored recycled plastic 8 ft. top and 6 ft. seats, wheelchair accessible on both ends.



Model APT/P/CN-6PA34, surface mount installation, green powder coated frames, 6 ft. long, 3" x 4" gray recycled plastic top and seats.

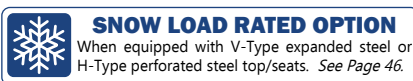

SNOW LOAD RATED OPTION
When equipped with V-Type expanded steel or H-Type perforated steel top/seats. See Page 46.



Model APT/P/G-8VW optional bolt down base plate installation, galvanized frames, 8 ft. long, thermo-plastic coated expanded steel in brown.



Model APT/G-6UP embedded post installation, galvanized frames, 6 ft., untreated pine.



Pair trash receptacles with picnic tables to help clean up the picnic mess.

TWIN PEDESTAL TABLE

- TPT Series

- **Model TPT** Twin Pedestal Tables provide a secure, permanent location, with twin steel support posts. The table can be 6 ft. or 8 ft. long (two pedestals) and 10 ft. long (three pedestals). Each table has two full-length bench seats. 31 inch table height, 18 inch seat height (nominal dimensions).
- Support posts are 4" x 1/8" wall sq. steel tube. Seat support arms are 2-1/2" x 3/16" wall sq. steel tube. Step over entry.
- Embedded post installation is standard.
- Frame finish: Hot dip galvanized or powder coated. *See Page 52.*

Available Materials. See Pages 52-57	Lengths (feet)
2x10 Untreated or Pressure Treated Pine	6, 8, 10
Aluminum	6, 8, 10
2x10 100% Recycled Plastic	6, 8
Thermo-plastic coated D-Type Expanded Steel or R-Type Perforated Steel	6, 8, 10
Formed Steel Channel	6, 8

• Wheelchair Accessible

- **/E Option:** 8 ft. top extends 2 ft. beyond 6 ft. seats at one end provides ADA compliant wheelchair access. Extended top is supported by a diagonal brace. *See Page 47.*
- **/E1 Option:** 8 ft. top extends 1 ft. beyond 6 ft. seats at each end provides ADA compliant wheelchair access, no diagonal brace under the two extended ends. *See Page 47.*



Model TPT/P/G-6UP with surface mount base plate, hot dip galvanized frames, 6 ft., untreated pine top and seats.



Model TPT/CB-6AL/E embedded mount, black powder coated frames, 6 ft., aluminum seats, 8 ft. aluminum top, extended 2 ft. at one end to allow wheelchair access.

- **Optional:** Twin frame posts provided with 3/8" x 10" sq. steel bolt down base plate (anchor bolts not included) for surface installation. *See Page 126.*

Model PT/P/G-6PR

with optional bolt down base plate installation, galvanized frames, red 100% recycled plastic.



Model PT/G-6UP with standard embedded post galvanized frames, untreated pine lumber.

- All PT Tables provide ADA compliant wheelchair accessible at both ends by design. *See Page 47.*



SINGLE PEDESTAL TABLE

- PT Series

- **Model PT** Pedestal Rectangular Tables provide a secure, permanent location. Table is 6 ft. long with two full-length bench seats. 32" table height, 21" seat height (nominal dimensions).
- Supported by one central, massive 5-3/8" sq. steel post. Embedded installation is standard. Seat support arms are 3-1/2" dia. steel tube, designed to resist lateral torsion and deflection. Single, central support post simplifies maintenance around table.
- Design points all fasteners to inside of central post so carriage bolt nuts are not exposed. Installation of top prevents access to inside of post.
- Frame finish: Hot dip galvanized or powder coated. *See Page 52.*

Available Materials. See Pages 52-57	Lengths (feet)
2x10 Untreated or Pressure Treated Pine	6
Aluminum	6
2x10 100% Recycled Plastic	6
Thermo-plastic coated D-Type Expanded Steel or R-Type Perforated Steel	6
Formed Steel Channel	6

- **Optional:** Frame post provided with 3/8" x 16" sq. steel bolt down base plate (anchor bolts not included). *See Page 126.*

SQUARE FRAME PICNIC & UTILITY TABLE - T700 Series

- **T700 Series** tables and utility tables offer a clean cut square end frame design with inlaid top and seat planks.
- Surface mount installation only. Anchor bolts not included. *See Page 126.*
- All steel, welded component construction. End frames are 2" x 2" x 11 ga. square steel tube. Top/seat framework is 1" x 2" x 14 ga. rectangular steel tube, with formed steel channel reinforcements. All open ends are welded closed with steel end caps.
- All steel frame components have a powder coat finish. *See Page 52.*
- Top/seat inlay materials 2" x 4" (nom.): 100% recycled plastic in choice of colors. All inlaid planks are installed at the factory. *See Page 54.*
- Assembly of end frames to top/seat components is required.
- **Wheelchair accessible:** All rectangular tables provide ADA compliant wheelchair access at both ends. A square table with three seats is also ADA compliant on one side. *See Page 47.*



Model T702/CB-8PA Picnic Table, black powder coat frames, 8 ft. long, 2" x 4" 100% recycled plastic planks in gray color.
ADA compliant wheelchair access at both ends of table.



Model TQ700/CN-4PC Square Utility Table, green powder coat frames, 4 ft. sq. top, 2" x 4" 100% recycled plastic planks in cedar color.



Model T700/CB-8PA Utility Table, black powder coat frames, 8 ft. long, 2" x 4" 100% recycled plastic planks in gray color.

**See matching benches on Page 4,
matching trash receptacles on Page 67 .**



Model TQ704/CE-4PY Square Picnic Table, burgundy powder coat frames, 4 ft. sq. top, 2" x 4" 100% recycled plastic planks in yellow color.

Table Model	Style	Length	Bench Seats	ADA Compliant Access	Top/Seat Inlay Material	Frame Finish
T700-6	Utility Table	6' Rectangular	None	Yes - All Sides	100% Recycled Plastic 2" x 4" (nom.) planks in cedar color (PC) is standard. Other colors available. <i>See Page 54.</i>	Powder coat black finish (CB) is standard. Other colors available. <i>See Page 52.</i>
T700-8	Utility Table	8' Rectangular	None	Yes - All Sides		
T702-6	Picnic Table	6' Rectangular	(2) 6'	Yes - Both Ends		
T702-8	Picnic Table	8' Rectangular	(2) 8'	Yes - Both Ends		
TQ700-4	Utility Table	4' Square	None	Yes - All Sides		
TQ703-4	Picnic Table	4' Square	(3) 4'	Yes - One Side		
TQ704-4	Picnic Table	4' Square	(4) 4'	No		

FOOD COURT TABLE

- FCT Series

- The open span frame design of Model FCT Food Court Table creates a clear area under and around the table for easy clean up.
- **Model FCT** provides surface mount (bolt down) installation provides a secure location. Screw anchors for concrete surfaces are included. *See Page 126.*
- **Model FCTL** includes four levelers to compensate for an uneven surface (surface anchoring not available).
- **FCT Series** tables are 4 ft. long and will comfortably seat four adults. The wide end openings allow strollers and wheelchairs to approach.



Model FCT/G-4RR Food Court Table, galvanized frames, 4 ft. long, surface mount, perforated steel top and seats thermo-plastic coated in red.



Model FCT/CW-4SP/CNT Food Court Table, brown powder coated frames, 4 ft. long, surface mount, steel plate top and seats with green textured powder coat paint finish. Shown with optional CC-1/CB frame foot cover caps.

- The small footprint of this table (48 inches long x 58 inches wide) gives you placement and arrangement flexibility.
- All welded frame fabrication includes: 2-3/8" OD steel pipe legs (2.375 in. OD, 11 ga. wall), with top and seat support/attachment brackets die formed using 10 ga. and 1/4" steel plate. The two frame structures bolt together under the table top.
- Standard frame finish: hot dip galvanized after fabrication.
- **Optional:** powder coated frame finish in choice of colors. *See Page 52.*
- Top/seat material choices: thermoplastic coated R-Type perforated steel (*page 57*) or solid steel plate with semi-gloss textured powder coat finish (*page 52*).
- **Optional:** 2-part aluminum cover caps for FCT surface mount/bolt down table frame posts only. *See page 50.*

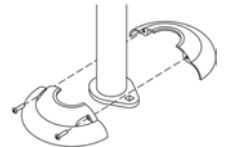

Your Picnic Sites, Shelter Houses and Food Courts may need additional furnishings:



Trash Receptacles



Charcoal Grills



Utility Tables



Park Benches



SNOW LOAD and EXTREME LOAD RATED TABLES



These Pilot Rock brand picnic tables have been designed and independently tested ...by an independent lab and a state university... to withstand high elevation snow loads and other extreme conditions. To achieve the following ratings, these steel frame tables must be equipped with our **V-Type expanded steel** or **H-Type perforated steel** top and seat structures. Standard and accessible tables are available. Remember ... the rating is Per Square Foot, not per table! When the snow melts these tables will be ready to use again.

Maybe it doesn't snow where you are? Just think how well these tables will hold up to public exposure in your parks!

500 LBS. PER SQUARE FOOT



Model WAT-8 A-Frame Table 8 ft. long and wheelchair accessible at both ends. The table structure uses **Recycled Plastic** leg posts and top/seat planks and incorporates steel braces for support. This table was tested to hold over 500 lbs. per sq. ft. load without failure. (see Page 35)

948 LBS. PER SQUARE FOOT



Models XT-/E and **XTH-/E** Extended End Wheelchair Accessible Tables with 8 ft. top and 6 ft. seats using **V-Type expanded steel** or **H-Type perforated steel** top/seats. The 2 ft. extension on the table top was tested to withstand over 948 lbs. per sq. ft. without failure. (see Page 30)

1420 LBS. PER SQUARE FOOT



Models WXT and **WXTH** Universal Access Tables in 6, 8, or 10 ft. lengths, with **V-Type expanded steel** or **H-Type perforated steel** top/seats. (see Page 32)



Model WPTS Universal Access Table in 6 ft. or 8 ft. lengths, with **V-Type expanded steel** or **H-Type perforated steel** top/seats. (see Page 33)



Model XT Standard Tables in 6, 8, or 10 ft. lengths, with **V-Type expanded steel** or **H-Type perforated steel** top/seats. (see Page 29)



Model APT Multi-Pedestal Tables and **APTX** Utility Tables in 6 ft. or 8 ft. lengths, with **V-Type expanded steel** or **H-Type perforated steel** top/seats. (see Page 42, 85)

ACCESSIBILITY COMPLIANCE

Toe Clearance: Space from the surface to 9 in. (230mm) high shall be considered toe clearance; toe clearance shall extend 17 in. (430mm) minimum under the element; toe clearance shall extend 6 in. (150mm) maximum beyond knee clearance at 9 in. high; toe clearance shall extend 25 in. (635mm) maximum under an element; toe clearance shall be 30 in. (760mm) wide minimum.

Knee Clearance: Space from 9 in. (230mm) and 27 in. (685mm) above the surface shall be considered knee clearance; knee clearance shall be 11 in. (280mm) deep minimum at 9 in. (230mm) above surface, and 8 in. (205mm) deep minimum at 27 in. (685mm) above the surface; knee clearance shall extend 25 in. (638mm) maximum under the element at 9 in. (230mm) high; knee clearance shall be 30 in. (760mm) wide minimum.

These dimensions create a Clearance Box that must fit under the picnic table to be an ADA compliant table. Many tables claim to be "wheelchair accessible" but they might not be "ADA compliant". Below are illustrations of some popular Pilot Rock brand picnic tables and how they meet or exceed the ADA guidelines for Compliance.

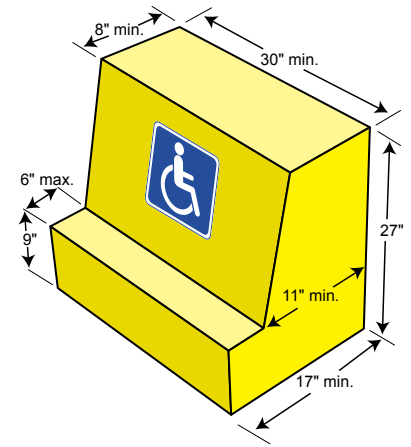

See Page 30

UT/UTH and XT/XTH Series tables with a two-foot extended top provide more than enough knee/toe space under the top.

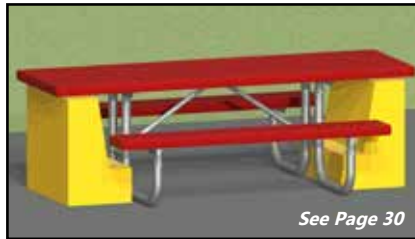

See Page 30

UT/UTH and XT/XTH Series tables with top extended one foot at each end meet accessibility guidelines.



See Page 30

UT and XT Series tables with side access provide wheelchair accessibility right in the middle of activities.



See Page 32

WXT & WXTH Series tables, provide all the required knee and toe clearances at both ends.



See Page 33

WPTS Series table offers ample room for the ADA Clearance Box to fit at both ends.



See Page 33

Model T720 tables with top extended one foot at each end meet accessibility guidelines.



See Pages 34-35

AT and AFT Series A-frame tables with a top extended one foot at each end meet accessibility guidelines.



See Page 36

T600 Series "Caterpillar" Tables are ADA compliant at both ends.



See Page 37

RT Series and ART Series Plastic Tables offer extended end table top options to ensure ADA Accessibility can be met.



See Page 39

PQT-4 Series with one seat removed provides ample wheelchair access.



See Page 43

TPT Series table with extended top allows the ADA Compliance Box to fit comfortably underneath.



See Page 43

PT Series tables provide a secure, permanent location and are wheelchair accessible at both ends by design.

Umbrellas



Model UM-4 Premium Acrylic Fabric Umbrella

- 7-1/2 ft. diameter, garden style.
- Eight 5.0 mm zinc plated steel ribs & stretchers. Galvanized steel bell cap. Non-twisting end tips.
- 1-1/2" OD silver anodized steel pole.
- Crank lift with steel cable, and EZ-Latch spring mechanism. Stainless steel double joints and rivets make opening and closing easy. No draft vent.
- 3-position tilt, heavy gauge mechanism, nylon runner.
- Premium acrylic fabric, 9 oz. marine grade, solution dyed, UV resistance. Available in solid and alternating colors:
- **Solid colors:** pacific blue, forest green, sunflower yellow, logo red.
- **Alternating colors:** pacific blue/white, forest green/white, logo red/white, and beach ball (red, yellow, blue, bright green).

Model UM-5 Economy Vinyl Umbrella

- 7-1/2 ft. diameter, garden style.
- Eight chrome plated steel ribs. Steel bell cap. Non-twisting end tips.
- 1-1/2" OD silver anodized steel pole.
- Crank lift with steel cable, and EZ-Latch spring mechanism. Stainless steel double joints and rivets make opening and closing easy. No draft vent.
- 3-position, heavy gauge tilt mechanism, nylon runner.
- Heavy gauge 13 oz. vinyl material available in solid or alternating colors:
- **Solid colors:** white, forest green, pacific blue, red, navy, kelly green, yellow.
- **Alternating colors:** forest green/white, kelly green/white, pacific blue/white, red/white, navy/white, yellow/white.



Model UM-11 Premium Acrylic Fabric Market Style Umbrella

- 9 ft. diameter, market style.
- Eight 1/2" thick Fiberglass ribs. Stainless steel grommets and hardware throughout. Draft vent.
- 1-1/2" Fiberglass pole, two sections. Wood grain finish.
- Commercial pulley system. No tilt.
- Premium acrylic fabric, 9 oz. marine grade, solution dyed, UV resistance. Available in solid colors only.
- **Solid colors:** pacific blue, forest green, navy blue, toast, logo red and white.
Other solid colors and alternating colors may be available. Please inquire.

Heat Shield for Picnic Table Tops

- **Model HS-TB/G** Heat Shield protects your picnic table top from the damage caused by the heat off small gas grills, charcoal grills, skillets, or Dutch Ovens that picnickers often bring with them.
- Protects wood, plastic and coated steel table tops from heat damage caused by hot cooking utensils.
- Designed for easy installation on most brands of tables, most styles of tops. Includes fastener package for 2" x 10" lumber or plastic, and expanded or perforated steel tops.
- Expanded steel surface with steel frame. No assembly required. Approximately 12" deep x 25-1/2" wide x 3-1/2" tall. Hot dip galvanized finish for maximum protection.



Table Top End Cap



- Install picnic table top end caps to prevent warping on new lumber, or to correct minor warpage on old lumber. Keep all top planks in alignment so your table remains usable.
- Use these formed pregalvanized steel channels to align the planks at both ends of your picnic table top. Especially useful on tables with lumber tops extended to provide wheelchair access.
- Table Alignment Kit includes (2) formed 28" long pregalvanized steel channels and wood screws (*install from bottom up*).
- Order Part Number **TAK-21G** for 2" nominal dim. lumber (2" x 4", 2" x 6", 2" x 8", 2" x 10").
- Order Part Number **TAK-31G** for 3" x 10" nom. dim. lumber.

Surface Mount Base Plate

- Optional bolt down base plate installations are available on Model PQT Square Tables, Model PT, APT, and TPT Rectangular Tables, and T400 Round Tables.
- The standard post is replaced by a shortened post with a welded on steel plate to be bolted to an existing surface. Anchor bolts are not included with this option. *See Page 126.*
- Model PQT, PT, and T400 Tables are equipped with a 3/8" x 15-3/4" square steel base plate.
- Model APT Table posts have a 1/4" x 8" sq. steel base plate.
- Model TPT posts include a 3/8" x 10" square plate. All have (4) 25/32" dia. anchor holes.



Backrests



(Above) Backrest on 48" square table.



(Right) Backrest on 6 ft. rectangular table. (This option is not available on UTK and SQT tables.)

- Optional Backrests are available on 6 and 8 ft. long UT, XT Rectangular Tables and SQT Series Square Tables. This option can be added to new or existing tables.
- Die-formed steel backrest bracket is sandwiched between seat plank and table frame for a secure, bolted installation.
- Backrest planks are available in lumber on rectangular tables; all materials on SQT tables.

Perforated Steel and Cut Steel Signage

- Perforated 2" x 12" steel benches (not contour), tables and trash receptacles can have custom lettering included to give a unique identity. Number and size of letters limited.
- Benches with cut steel plate seats can include a custom cut design.



Cover Caps



- Two-part Cover Caps for Park Benches, Picnic Tables, Bike Racks and More. Use on any T600 Caterpillar Table model (page 36) and FCT Food Court Table model (page 45).
- Each half is cast aluminum, with no coating. Requires 5/32-inch hex key (Allen wrench) to assemble (not included). Fasteners included.
- 2-1/2 inch diameter center hole will fit all 2-3/8" OD frame posts. 8-inch outside diameter.
- Available with aluminum finish to match galvanized frame posts. Or can be powder coated to match the painted frame finish. Cover caps not available with thermo-plastic coated components.
- Order (1) pair Model CC-1 cover cap for each frame post.

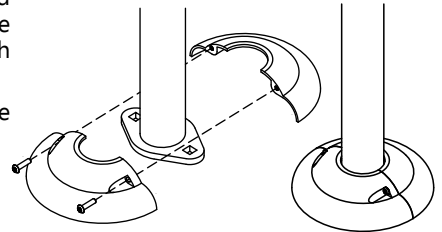

Umbrella Base

- **Model UMB/B-1 Umbrella Base** is designed to be used with a picnic table to hold an umbrella pole under the table, when the pole is inserted through a hole in the table top. The hole in the table top and this base combination will hold the umbrella vertical and secure.
- Features include: 23-3/8 in. dia. disc base, 1-5/8 in. ID (1.90 in. OD) x 6 in. long receiving pipe, thumb set screw with knob, required hardware to assemble.
- Weight: 20 lbs. Finished with black enamel.
- This umbrella base is **NOT** designed to hold an umbrella alone. It can only be used underneath a picnic table, and the umbrella pole must be inserted through a hole in the table top.



Gameboard Top



- **Game Board Table Top** is available on select tables with thermo-plastic coated expanded or perforated steel.
- The Game Board insert is 14 ga. steel powder coated black.
- The Game Board insert measures 29-5/8 in. x 29-5/8 in. on square tables; 31-1/4 in. x 31-1/4 in. on round tables.
- After the vinyl game decal is applied the insert is sealed with a clear coat finish.
- The standard game decal is a red/black checkerboard.
- Use with table models SQT, PQT, T100, T104K, T200, T300, T400.

MAINTENANCE TIPS FOR PICNIC TABLES & BENCHES

Moving Picnic Tables & Park Benches

If you move or relocate any picnic tables or park benches, look for any frame components that may get damaged during this handling. If diagonal braces that support the frame structure get damaged, they should be replaced to keep the structure sound. Be sure to check all fasteners. They can work loose over time, especially if the tables or benches are moved often.

Rust

A galvanized finish is more durable and resistant to scratching and exposure over time than a painted finish. The best galvanized finish is called hot dip galvanized after fabrication. This finish will require almost no maintenance under normal use.



Frame components made of pre-galvanized steel, are usually lightweight and perform quite well in many applications. However, any areas that have been cut or drilled will expose the underlying steel and may develop rust over time. Be most concerned about any points on pre-galvanized steel that have been welded. The welding heat can burn off the pre-galvanized finish exposing the steel. These weld points must be cold galvanized, which could be equated to a sprayed on painted finish.

Painted frame finishes are popular because many color options are available. Most manufacturers now use a dry powder coat paint application process vs. liquid paint. In most common installations, this finish will serve well for many years. However, if the paint is chipped or scratched, the exposed metal can begin to rust. These areas must be sanded and repainted before the rust expands too far. You should expect to do more touch up maintenance on painted steel components for park furniture used by the public.

Picnic Table & Park Bench Top/Seat Materials

Lumber

Wood top and seat planks will require the most attention to compensate for outdoor exposure. Different species of wood will react differently to the constant variations in sunlight, temperatures, moisture and insects. Warping and weather checking are typically the result.

Pressure treated wood can successfully fight off these abusive elements longer than untreated woods. Most lumber should be regularly water sealed or painted to protect it from UV rays and moisture. We recommend lumber be inspected and protected annually for best results. Refer to the instructions on the brand of sealant or paint that you decide to use.

All lumber is graded and grading stamps on the lumber are common and unavoidable. If these grading stamps are objectionable, you can remove them by sanding the lumber. The stamps will also likely fade over time from weather exposure.



Recycled Plastic

The 100% recycled plastics are impervious to the weather elements and insects. They include a UV stabilizer for UV protection. They are resistant to mold and chemicals, and will not splinter or rot. Recycled plastic is a great material for many locations. Cleaning is the most common maintenance need. The solution is as simple as washing off any accumulated grime with a mild detergent.

Aluminum

Aluminum components do not suffer from exposure to sunlight, insects, moisture or temperature. Rusting and rotting are not issues here. One maintenance concern could be caused by the lightweight nature of these products. For example, aluminum picnic tables are easier to move around. So periodically check all the fasteners to be sure that the product structure is tight and secure for public use. Aluminum components can easily be kept clean with water and a mild detergent.

Thermoplastic Coated Steel

As long as the thermoplastic coating is not damaged and remains intact, these components can easily be cleaned with water and a mild detergent. The coating includes a UV stabilizer so the effects of constant sun exposure will be reduced and delayed.

However, the thermoplastic coating can be damaged by high heat or vandalism. Charcoal or gas grills and hot cooking pans should not be placed directly on top of the thermoplastic coating. The heat can deform the coating. Our heat shield (see page 49) can help protect your table from these heat sources. Vandals can deface the coating. If the steel core is exposed, it will be subject to rusting. Most manufacturers of plastic coated steel components can supply repair kits for small damaged areas. The patched area will not exactly match the original coating, but the steel core will be covered and protected.



HOT DIP GALVANIZED FINISH

Selected Pilot Rock bench and table frame components, lantern holders, trash receptacle holder components, bike racks and two grills are available with a hot-dip galvanized finish that is applied after fabrication and welding to ASTM-A123 specifications to maintain an average zinc coating of 2.0 oz. per sq. ft. of surface area. Use "/G" in model number for hot dip galvanized finish, e.g. XT/G-6UP.

Hot dip galvanized finish products are ideally suited for humid coastal and island area environments. The combination of moisture and salt exposure causes any steel exposed by a scratch in the paint to quickly rust. Hot dip galvanized finishes involve a seven step liquid immersion process. These steps and the high temperature create a metallurgical bond where the iron in the steel products bonds with the zinc to achieve complete adhesion of the carbon (steel) product with the zinc (galvanizing) material. This process allows for complete coverage on all sides of the steel products – including the inside and outside of tubular products, such as picnic table legs and welded points.



HEAT RESISTANT BLACK ENAMEL PAINT

Pilot Rock grills and campfire rings are finished with a high heat resistant, non-toxic, matte (low gloss) black enamel paint. This silicone-based paint is lead and chrome free and formulated especially for Pilot Rock. It is capable of enduring temperatures exceeding 750 degrees.

Once cured, this creates a strong heat and scratch resistant coating, but is not fully cured upon delivery and will not fully cure until after its initial fire. The heat resistance in this paint is created by a silicone additive which needs a high temperature to cure leaving the paint somewhat soft and less resistant to scratching until its initial fire. Paint drips and small scratches that occur during shipping are often eliminated as the paint gels during its first fire. Larger scratches or scrapes can be treated with a high heat aerosol touch up paint and will blend in after the next fire. Annual maintenance is recommended to clean and spray any areas where the coating may be damaged. It is also highly recommended to remove the ashes from your grill or firering regularly to allow any trapped moisture to evaporate.



POWDER COAT FINISH

Selected Pilot Rock bench and table components (steel and aluminum), lantern holders, trash receptacle holders, and bike racks are available with baked on lead-free TGIC polyester powder coat finish that is applied in a multi-step process of material preparation and finish application. This process includes: detailed chemical cleaning; application of a corrosion inhibiting phosphate-free high pressure, high temperature bath; rinse; seal rinse; high temperature dry time; electrostatic application of the powder coat paint; chemical bonding to metal substrate in 430 degree industrial oven. The tough 3 mil thick coating offers a superior finish to liquid paints.

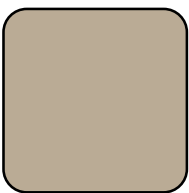

Tan
(CT) for steel
(AT) for aluminum



Blue
(CU) for steel
(AU) for aluminum



Black
(CB) for steel
(AB) for aluminum

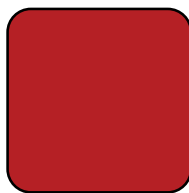

Red
(CR) for steel
(AR) for aluminum



Brown
(CW) for steel
(AW) for aluminum

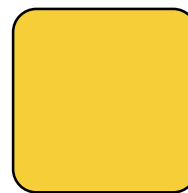

Yellow
(CY) for steel
(AY) for aluminum



Green
(CN) for steel
(AN) for aluminum

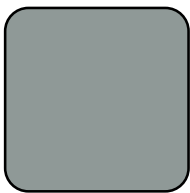

Gray
(CA) for steel
(AA) for aluminum

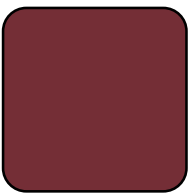

Burgundy
(CE) for steel
(AE) for aluminum

Model No. Example for Powder Coat Finish products: XT/◆-6UP
Replace (◆) with letters indicating color choice listed under sample.

NOTE: Custom colors may be available when ordered in sufficient quantity and additional lead times.

Note: Colors and textures may vary. Colors shown are as close to the actual colors as the printing process is able to reproduce them. When selecting colors, keep in mind that Thermo-plastic Coating, Powder Coating and Recycled Plastic may not be exactly the same color -- i.e., Blue Thermo-plastic Coating for seats and/or table tops and Blue Powder Coating for frames may differ slightly.

TEXTURED POWDER COAT FINISH

We use a semi-gloss textured powder coat paint finish on our BPRT bear resistant trash/recycling receptacles, our BPFL bear resistant food storage lockers, and on the solid steel plate top/seats for the FCT-4 food court table. As with standard powder coat finish, this is a baked on lead-free TGIC polyester powder coat finish that is applied in a multi-step process of material preparation and finish application. This process includes: detailed chemical cleaning; application of a corrosion inhibiting phosphate-free high pressure, high temperature bath; rinse; seal rinse; high temperature dry time; electrostatic application of the powder coat paint; chemical bonding to metal substrate in 430 degree industrial oven. The tough 3 mil thick coating offers a superior finish to liquid paints.

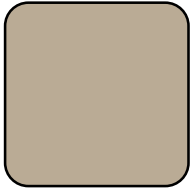

Speckled Tan
Use (CTT) in
model no.



Blue
Use (CUT) in
model no.



Black
Use (CBT) in
model no.



Green
Use (CNT) in
model no.



Brown
Use (CWT) in
model no.

NOTE: Custom colors may be available when ordered in sufficient quantity and additional lead times.

Model No. Example for Textured Powder Coat Finish products: BPFL/◆-15 Replace (◆) with letters indicating color choice listed under sample.

UNTREATED #1 SOUTHERN YELLOW PINE

Untreated #1 grade Southern Yellow Pine planks, kiln dried to reduce moisture content. The lumber is ready for you to water seal, paint or stain. All lumber is precision drilled to facilitate assembly. All exposed edges are removed to 3/8" radius. Use "UP" in model number for untreated pine. Tables use 2" x 10" planks. All dimensions are nominal.



TREATED #1 SOUTHERN YELLOW PINE

Treated #1 grade Southern Yellow Pine is pressure treated and kiln dried after treatment (KDAT) to reduce moisture content. Wood preservative (no arsenic) gives superior protection against termites, insects and decay. The lumber is clean to handle, dry and ready for you to water seal, paint or stain. All lumber is precision drilled to facilitate assembly. All exposed edges are removed to 3/8" radius. Use "TP" in model number for treated pine. Tables use 2" x 10" planks. Benches can use 2" x 4" or 2" x 10" planks (varies by model). Trash receptacles use 2" x 4" slats. All dimensions are nominal.



CONSTRUCTION HEART REDWOOD

Construction heart redwood is a popular alternative to pine. Select timbers are made from the interior grain of American Redwood. Redwood naturally resists decay. It is available only in 3" x 4" (nominal) lumber dimension. All lumber is precision drilled to facilitate assembly. All exposed edges are removed to a 3/8" radius. This grade allows for knots up to 2-1/2" dia. Use "CO" in model number for construction heart redwood.



EXOTIC IMPORTED HARDWOODS

Exotic imported hardwoods exhibit high resistance to decay, water damage and physical damage without the use of chemical treatments. Their features often imitate redwood. All of these hardwoods are imported from managed forests. Species may vary depending on availability and cost. Please inquire.



Other species of lumber: cedar, fir and clear redwood may be available when in stock. Please inquire.

Note: Colors and textures may vary. Colors shown are as close to the actual colors as the printing process is able to reproduce them. When selecting colors, keep in mind that Thermo-plastic Coating, Powder Coating and Recycled Plastic may not be exactly the same color -- i.e., Blue Thermo-plastic Coating for seats and/or table tops and Blue Powder Coating for frames may differ slightly.

ALUMINUM

Several select picnic tables and benches can be equipped with seats/top or seat/back of aluminum planks. These planks are extruded 6063-T6 aluminum, equivalent in size to 2" x 10" (nominal) lumber planks. Four structural ribs provide rigid support and strength. The aluminum is clear anodized to specification 204 R1 for a clean, maintenance free finish. All plank ends are covered by an extruded, clear anodized aluminum end cap fastened into place. Table tops are made into single units (at the factory) by connecting the planks with one-piece end caps fastened across each end of the top. Aluminum planks are provided with precision fitted aluminum brackets and galvanized carriage bolts to attach planks to table or bench frames. Use "AL" in model number for clear anodized aluminum, e.g. XT/G-6AL.

Optional: Aluminum (mill finish) components (max. 12 ft. length) are also available with powder coated finish. See *Powder Coat Finish* description for details.



100% RECYCLED PLASTIC - Timbers, Planks and Frames

Our recycled plastic material is 100% recycled high-density polyethylene and is formed using a combination of post-consumer and post-industrial waste plastics. There is no virgin plastic in this product. Post-consumer plastic has been used by a consumer and then recycled to avoid dumping in a landfill (such as milk jugs). Post-industrial plastics have gone through a manufacturing process but never reached the consumer (such as product rejects or process wastes). On average our product is 80% post consumer and 20% post industrial (percentages can vary). Our plastic components are 100%

recycled and can also be recycled again and again. There are no toxic chemicals in this product. Plastic by its very nature does not leach.

A solid color is formed throughout the component and a UV stabilizer is added for ultraviolet protection. This recycled plastic is a dense, durable product, offering a long lasting, attractive appearance. It will not splinter or rot, and is resistant to mold and insects. These components are molded into solid dimensional shapes corresponding to nominal lumber dimensions. Recycled plastic components are available in your choice of colors.



Red

Use **PR** in model no.

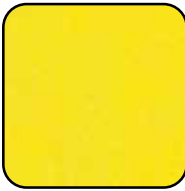

Yellow

Use **PY** in model no.



Black

Use **PB** in model no.



Blue

Use **PU** in model no.



Weathered Wood

Use **PD** in model no.



Cedar

Use **PC** in model no.



Green

Use **PN** in model no.



Gray

Use **PA** in model no.



Brown

Use **PW** in model no.

Model No. Example for Recycled Plastic products: PCXB/G-4♦24 Replace (♦) with letters indicating color choice listed under sample.

Note: Custom colors and textures may be available when ordered in sufficient quantity and additional production lead times.

GRAFFITI REMOVAL SUGGESTIONS

Our recycled plastic lumber is extremely chemical resistant to very harsh chemical removers.

There are several graffiti removal tools on the market that could be used on our plastic lumber. Harsh graffiti removers like MEK, NexGen, and Gasoline solutions will not harm the plastic lumber. Be sure to wash off any residue.

Pressure washing, with detergent added, will remove most dirt, grime,

markings, and debris. When pressure washing, start with the tip far away, and then gradually move closer to the plastic lumber to avoid gouging the plastic lumber with too aggressive of a pressure wash.

If the substance is ground in, oily or sticky; some type of solution will be needed to loosen up the stain to get it out of the textured surface of the plastic lumber.

Note: Colors and textures may vary. Colors shown are as close to the actual colors as the printing process is able to reproduce them. When selecting colors, keep in mind that Thermo-plastic Coating, Powder Coating and Recycled Plastic may not be exactly the same color -- i.e., Blue Thermo-plastic Coating for seats and/or table tops and Blue Powder Coating for frames may differ slightly.

THERMO-PLASTIC COATED FORMED STEEL PRODUCTS

Selected Pilot Rock bench, table and trash receptacle products and components featuring cut/formed steel are finished with a thermo-plastic coating in your choice of available colors. **The thermo-plastic coating is PVC free and phthalate free.**

The UV-stabilized thermo-plastic coating is applied in a multi-step process of material preparation and finish application, designed and formulated to create superior adhesion. After cleaning, the steel component is heated to 550-600 degrees (depending on the component). It is then lowered into an air-fluidized bed of colored polyethylene powder. This fluid powder fuses and bonds to the heated metal. The component is then baked at high temperature to cure the application. This dipping application provides a coating 35-40 mils thick (as much as 5x thicker than a spray-on coating).

This complete process of cleaning-heating-fusing-baking tightly bonds the powder to the metal, creating a durable, colorfast finish. The thermo-plastic finish includes a superior level of UV protection, does not support mold or mildew growth, and is impact resistant. We use a textured matte finish polyethylene. These finishes are less susceptible to marring and scratching (which is often a problem with gloss finishes).

Cut/formed steel components are assembled and reinforced with formed steel edge bands, angle irons and bars as appropriate to each product design. All components are single piece welded construction.

 Our thermocoat product has been tested by an independent lab, and given the highest rating of DNI - **Does Not Ignite** and does not support combustion during or after flame exposure.

FORMED STEEL CHANNEL

- Looks like 2x4 lumber. Has the strength of steel.

Formed steel channel (SC) components approximate 2" x 4" lumber dimensions, but are formed using 16 ga. steel plate with 16 ga. bracing. These tops and seats are strong and light weight. Formed steel channels (SC), steel end caps and understructure bracing are pre-assembled at the factory for easier onsite assembly. After assembly each component is thermoplastic coated (T). See the color chart below. Use "/T♦" in model number to specify color choice.





STEEL STRAP AND CUT STEEL PLATE

Several steel components (besides expanded and perforated steel) can also be finished with a thermo-plastic coating. These different steel component designs have different Model Number designators. Each component is thermoplastic coated (T). See the color chart below. Use "/T♦" in model number to specify color choice.

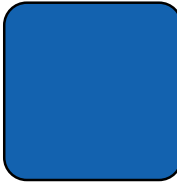
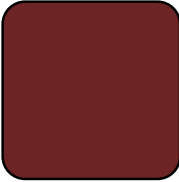
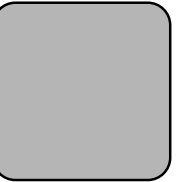
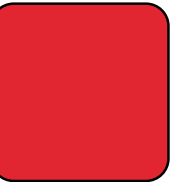
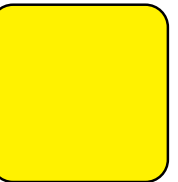

Steel Material	Thermo-plastic coated steel material is currently available on these products:
Formed Steel Channel (SC)	Most rectangular picnic tables (6' & 8'); CXB, AB, APB, and WMB Benches (6' & 8')
Steel Strap (SS)	CN-R/SS3-36 trash receptacle; P-23 Planter
Cut Steel Plate (SP)	B70 and B120 benches; T Series round tables, CN-R/SP2-32 trash receptacle
Other Steel Products	BR20 bike rack; HRP and HRE bike racks; CN-EXP52 park policeman

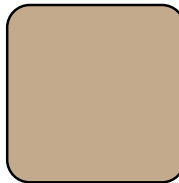
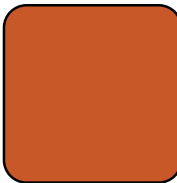
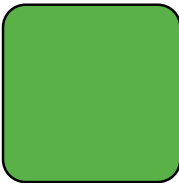
						
Black Use (TB) in model no.	Blue Use (TU) in model no.	Brown Use (TW) in model no.	GRAY Use (TA) in model no.	Red Use (TR) in model no.	Yellow Use (TY) in model no.	Green Use (TN) in model no.
						
Tan Use (TT) in model no.	Orange Use (TO) in model no.	Light Green Use (TLG) in model no.				

Example for Steel Strap, Steel Channel, Steel Plate products:

B122/CB-4SP/♦ Replace (♦) with letters indicating type and color listed under sample.

Note: Colors and textures may vary. Colors shown are as close to the actual colors as the printing process is able to reproduce them. When selecting colors, keep in mind that Thermo-plastic Coating, Powder Coating and Recycled Plastic may not be exactly the same color -- i.e., Blue Thermo-plastic Coating for seats and/or table tops and Blue Powder Coating for frames may differ slightly.

THERMO-PLASTIC COATED EXPANDED STEEL

Selected Pilot Rock bench, table and trash receptacle products and components featuring expanded steel are finished with a thermo-plastic coating in your choice of available colors. **The thermo-plastic coating is PVC free and phthalate free.**

The UV-stabilized thermo-plastic coating is applied in a multi-step process of material preparation and finish application, designed and formulated to create superior adhesion. After cleaning, the steel component is heated to 550-600 degrees (depending on the component). It is then lowered into an air-fluidized bed of colored polyethylene powder. This fluid powder fuses and bonds to the heated metal. The component is then baked at high temperature to cure the application. This dipping application provides a coating 35-40 mils thick (as much as 5x thicker than a spray-on coating).

This complete process of cleaning-heating-fusing-baking tightly bonds the powder to the metal, creating a durable, colorfast finish. The thermo-plastic finish includes a superior level of UV protection, does not support mold or mildew growth, and is impact resistant. We use a textured matte finish polyethylene. These finishes are less susceptible to marring and scratching (which is often a problem with gloss finishes).

Expanded steel components are assembled and reinforced with formed steel edge bands, angle irons and bars as appropriate to each product design. All components are single piece welded construction.

 Our thermocoat product has been tested by an independent lab, and given the highest rating of DNI - **Does Not Ignite** and does not support combustion during or after flame exposure.

TWO TYPES OF EXPANDED STEEL COMPONENT DESIGNS

All of the D-Type and V-Type expanded steel that we use is 3/4"-#9 material with a short longitudinal stretch. A shorter stretch means smaller "diamond" openings, which leaves more material (steel) per foot. The more diamonds there are per lineal foot is your indication that there is more steel left in the structure. Therefore, the top and seats will be stronger. It is also called the "long way design, non flattened expanded metal". "Non flattened" means the steel is "on edge" around the diamonds. This provides a stronger, more rigid material.

D-Type: This standard duty table top/seat and other component design is built for your most common public use applications.

V-Type: SNOW LOAD/EXTREME LOAD RATED. This design incorporates wider edge banding and more structural supports to create a table built for applications and locations that can be more abusive to the structure. This material is especially suited for high elevation areas where winter snow load can destroy average tables. The V-Type Snow Load/Extreme Load design is available on WXT, WXTH, WPTS, XT, XTH, APT, and APTX series tables. *See Page 46.*



NOTE: V-Type components are used on some benches and square tables. These applications have not been tested or rated for extreme loads.



Black
Use **DB** or **VB**
in model no.



Blue
Use **DU** or **VU**
in model no.



Brown
Use **DW** or **VW**
in model no.



Gray
Use **DA** or **VA**
in model no.



Red
Use **DR** or **VR**
in model no.

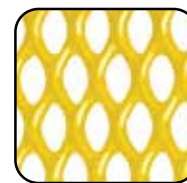

Yellow
Use **DY** or **VY**
in model no.



Green
Use **DN** or **VN**
in model no.



Tan
Use **DT** or **VT**
in model no.



Orange
Use **DO** or **VO**
in model no.



Light Green
Use **DLG** or **VLG**
in model no.

Examples using Expanded Steel products:

Model WXT/G-6D is equipped with standard duty top/seat structures for regular applications.

Model WXT/G-6V is equipped with the snow load rated top/seat structures for more extreme applications.

Replace (♦) with letters indicating type and color listed under sample.

Note: Colors and textures may vary. Colors shown are as close to the actual colors as the printing process is able to reproduce them. When selecting colors, keep in mind that Thermo-plastic Coating, Powder Coating and Recycled Plastic may not be exactly the same color -- i.e., Blue Thermo-plastic Coating for seats and/or table tops and Blue Powder Coating for frames may differ slightly.

THERMO-PLASTIC COATED PERFORATED STEEL

Selected Pilot Rock bench, table and trash receptacle products and components featuring perforated steel are finished with a thermo-plastic coating in your choice of available colors. **The thermo-plastic coating is PVC free and phthalate free.**

The UV-stabilized thermo-plastic coating is applied in a multi-step process of material preparation and finish application, designed and formulated to create superior adhesion. After cleaning, the steel component is heated to 550-600 degrees (depending on the component). It is then lowered into an air-fluidized bed of colored polyethylene powder. This fluid powder fuses and bonds to the heated metal. The component is then baked at high temperature to cure the application. This dipping application provides a coating 35-40 mils thick (as much as 5x thicker than a spray-on coating).

This complete process of cleaning-heating-fusing-baking tightly bonds the powder to the metal, creating a durable, colorfast finish. The thermo-plastic finish includes a superior level of UV protection, does not support mold or mildew growth, and is impact resistant. We use a textured matte finish polyethylene. These finishes are less susceptible to marring and scratching (which is often a problem with gloss finishes).

Perforated steel components are assembled and reinforced with formed steel edge bands, angle irons and bars as appropriate to each product design. All components are single piece welded construction.

 Our thermocoat product has been tested by an independent lab, and given the highest rating of DNI - **Does Not Ignite** and does not support combustion during or after flame exposure.

TWO TYPES OF PERFORATED STEEL COMPONENT DESIGNS





All of the R-Type and H-Type perforated steel is 14 ga. with 9/16" diameter holes punched on 13/16" straight line centers. Since material is perforated on site, it is perfect for use when ordering custom benches, tables and trash receptacles.

R-Type: This standard duty table top/seat and other component design is built for your most common public use applications.

H-Type: SNOW LOAD/EXTREME LOAD RATED. This design incorporates wider edge banding and more structural supports to create a table built for applications and locations that can be more abusive to the structure. This material is especially suited for high elevation areas where winter snow load can destroy average tables. The H-Type Snow Load/Extreme Load design is available on WXT, WXTH, WPTS, XT, XTH, APT, and APTX series tables. See Page 46.

NOTE: H-Type components are used on some benches and square tables. These applications have not been tested or rated for extreme loads.

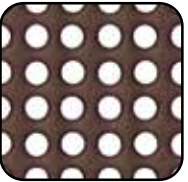
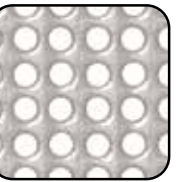
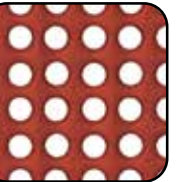
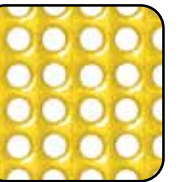

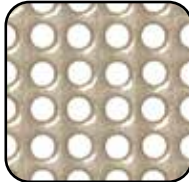
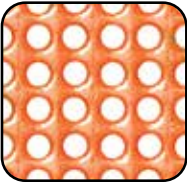
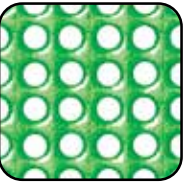
						
Black Use RB or HB in model no.	Blue Use RU or HU in model no.	Brown Use RW or HW in model no.	Gray Use RA or HA in model no.	Red Use RR or HR in model no.	Yellow Use RY or HY in model no.	Green Use RN or HN in model no.
						
Tan Use RT or HT in model no.	Orange Use RO or HO in model no.	Light Green Use RLG or HLG in model no.				

Examples using Perforated Steel products:

Model XT/G-8R♦ is equipped with standard duty top/seat structures for regular applications.

Model XT/G-8H♦ is equipped with the snow load rated top/seat structures for more extreme applications.

Replace (♦) with letters indicating type and color listed under sample.

Note: Colors and textures may vary. Colors shown are as close to the actual colors as the printing process is able to reproduce them. When selecting colors, keep in mind that Thermo-plastic Coating, Powder Coating and Recycled Plastic may not be exactly the same color -- i.e., Blue Thermo-plastic Coating for seats and/or table tops and Blue Powder Coating for frames may differ slightly.

BEAR RESISTANT TRASH RECEPTACLE

Designed and tested to keep bears -and other animals- out.

- **Construction:** Welded heavy 12- and 14-ga. formed steel with 7-ga. reinforcing and base.
- **Front Access Door:** The front door design provides easier access to the liner inside and more installation location options. Two latch points per door keep the door(s) tightly closed.
- **Large Hatch Opening:** The 16-inch square top hatch is secured by a commercial duty stainless steel hinge and self-closing latch. Guards over and in front of this latch restrict access to human fingers and keep bears out.
- **Standard Equipment:** 36-gallon heavy duty rigid plastic liner(s), four- or six-point surface anchor base with 1/2" x 5" concrete screw anchor bolts (unit must be anchored to be considered bear proof), stainless steel continuous piano hinge on the hatch and doors, interior rain drain to siphon away any leakage, choice of decal for top hatches, tightly fitted top hatch and front door(s). ADA compliant for forward and side reach ranges.
- **Finish:** Textured powder coat paint available in five colors: brown (/CWT), green (/CNT), blue (/CUT), speckled tan (/CTT) and black (/CBT). See page 53.
- **Optional:** Band-It trash bag loop to hold your removable trash bag (if you use them) on the included rigid liners. See Page 72.
- **Optional:** Steel recycling plate installed under the top hatch, powder coated Black only. Three holes sizes – choose the hole size that fits your recyclables.
 - BPRP-PC1 has 3" dia. hole.
 - BPRP-PC5 has 4-3/8" dia. hole.
 - BPRP-PC6 has 5-7/8" dia. hole.



Model BPRT1/CWT-36 bear resistant receptacle with brown textured powder coat finish, includes liner.



Model BPRT3/CUT-108 three-module trash and recycling receptacle, blue textured powder coat finish. Doors open showing included plastic liners.



Model BPRT2/CNT-72 two-module bear proof trash and recycling receptacle green textured powder coat finish. Shown with optional padlock.



- CANS ONLY**
DE-1
- PAPER ONLY**
DE-2
- PLASTIC ONLY**
DE-3
- GLASS ONLY**
DE-4
- ALUMINUM ONLY**
DE-5
- TRASH ONLY**
DE-11
- RECYCLE ONLY**
DE-19

MODEL NO.	IGBC CERT. #	MODULES	36 GAL. LINERS INCLUDED	DIMENSIONS H x W x D (INCHES)	DOOR OPENING H x W (INCHES)	OPTIONAL RECYCLING PLATE	DECAL CHOICES	ANCHOR KIT INCLUDED
BPRT1-36	5106	1	1	47 x 25-1/8 x 26-5/8	29-1/8 x 22	BPRP-PC1 3" dia. hole	DE-1 DE-2 DE-3	ANC5-4
BPRT2-72	5124	2	2	47 x 47-1/8 x 29	29-1/8 x 44	BPRP-PC5 4-3/8" dia. hole	DE-4 DE-5	ANC5-6
BPRT3-108	5107	3	3	47 x 68-5/16 x 29	29-1/8 x 44	BPRP-PC6 5-7/8" dia. hole	DE-11 DE-19	ANC5-6

*Certified by the Grizzly and Wolf Discovery Center (GWDC) using the Interagency Grizzly Bear Committee (IGBC) protocol.



VARMINT DEFIANT TRASH CAN COVER

Keep all kinds of varmints, critters, small animals and other assorted pests out of your trash.

- **Construction:** Heavy gauge welded steel (16, 12, 10, and, 7 ga. steel) fabrication, mounted on 3-1/2" OD x 1/8" wall steel post. Brown powder coat finish is standard.

- **2 Installation Methods:**

- Model CN-VDT-32** uses an embedded post into concrete footing (standard);

- Model CN-VDT/P-32** provides a bolt down base plate (1/4" x 8" x 8") for a concrete surface (includes anchor kit #ANC5-4 set of (4) 1/2" x 5" concrete screw anchors).

- **Operation:** The heavy weight hinged cover holds your steel can down, in place. The retainer ring keeps animals from knocking the can out at the bottom. Pull the front door open and its tail closes the throat of the lid. No animal can pull open the door and reach down into the trash can. Place your trash inside the door. When it closes your trash drops into the can. The front door is weighted and balanced to close on its own.



Model CN-VDT-32 standard installation is with the embedded post into a concrete footing as illustrated. Pull the cover back to locked position. Then empty trash can.



Model CN-VDT/P/CN-32 with optional surface mount base plate, green powder coat finish, and optional **Model CNG-WHD32C** steel trash can.

- **Security:** The top can be padlocked in the down position so only authorized persons can lift it and empty trash. Padlock is included.

- **Remove Trash:** Pull the top backwards and it latches in the open position. Lift trash can up, out of the retainer ring, empty and replace. Lower the lid and padlock closed.

- **Optional:** We recommend using Federal Duty trash can **Model CNG-WHD32C** (not included, order separately). This heavy weight galvanized steel can is strong enough to deter most animals. See Page 73.

- **Optional:** Your choice of powder coat colors. See Page 52.

- **Optional:** Band-It trash bag loop to hold your trash bag in place. See Page 72.

This item is not rated to be bear proof. Larger bears may be able to crush your metal can.



PARK POLICEMAN

- **Model CN-EXP52** offers a large 48-gallon capacity. The tapered body is 23-1/2" diameter at the top and 19-1/2" diameter at the bottom, 33" tall.

- This heavy-duty waste receptacle is fabricated using expanded metal mesh for the body, with rolled top and bottom edging for added strength, safety and easy handling. Six vertical ribs and two horizontal rings reinforce the whole structure. The hot dip galvanized finish is standard.

- **Optional:** Trash and recycling lids. See Pages 68-71.

- **Optional:** Thermo-plastic coat finish (instead of galvanized finish). See Page 56.

- **Optional:** Seasonal ground anchors. See Page 74.

Model CN/G-EXP52 Receptacle and optional **Model CN/G-5555** lid.



Model CN/TY-EXP52 Receptacle with yellow thermo-plastic coating and optional **Model CN-PD/Y-24** plastic dome lid.

ROUND RECEPTACLE - Vertical Steel Straps



(Above) **Model CN-R/SS2/CU-36** receptacle, blue powder coat finish. Shown with optional **Model CN-PD/U-24** blue plastic dome lid.

- **Model CN-R/SS2-36** trash receptacle is designed to hold most available 30 to 36 gallon liners.
- Fabricated using 1/8" thick x 2" wide steel vertical ribs. The top flares out to include a 1" diameter steel tube ring. The base structure includes a steel flange ring and cross braces with holes to provide anchor points for surface mounting. (Anchor bolts not included.) All components are welded into a single unit. No assembly required.
- Powder coat finish in your choice of colors. See Page 52.



(Left) **Model CN-R/SS2/CN-36** receptacle, green color with optional **Model CN/B-1825** molded plastic lid and **Model CN/B-1827** plastic liner.



Model CN-R/SS2/CE-36 receptacle, burgundy color with optional **Model CN-SDR/B-24** plastic dome lid and **Model CN/B-1827** plastic liner.

- Four threaded adjustable levelers located equally around the base ring allow for installation on uneven surfaces.
- **Optional:** Steel or rigid plastic liners. See Page 73.
- **Optional:** Trash and recycling lids. See Pages 68-71.
- **Optional:** Stationary mounts are available. See Page 74. For surface anchors see Page 126.

ROUND RECEPTACLE - Perforated Steel



Model CN-R/RW-32 Round Perforated Steel Trash Receptacle Holder for 32 gal. containers, brown thermo-plastic coated. Shown with optional **Model CN-PD/W-24** brown plastic dome lid.

- Fabricated from a single piece of 14 ga. perforated steel (round holes) and reinforced with 10 ga. top and bottom rings and die-formed cross braces across the bottom providing holes for surface anchoring options. All welded construction, no assembly required.
- Available in 3 standard sizes, see chart below for details.
- **Standard:** Receptacle is coated with UV-stabilized thermo-plastic. Replace (♦) in model number with letter of desired color. See Page 57.
- **Optional:** Receptacle is hot dip galvanized after fabrication (instead of thermo-plastic coating).
- **Optional:** Galvanized steel or rigid plastic liners. See Page 73.
- **Optional:** Trash and Recycling Lids. See Pages 68-71.
- **Optional:** Stationary mounts. See Page 74. For surface anchors see Page 126.

(Right) **Model CN-R/RB-32** Round Perforated Steel Trash Receptacle Holder for 32 gal. containers, black thermo-plastic coated. Shown with optional **Model CN-SDR/R-24** red plastic dome lid.



Model CN-R/R/G-55 Round Perforated Steel Trash Receptacle Holder for 55 gal. containers, hot dip galvanized finish. Shown with optional **Model CN-PD/C-27** cedar plastic dome lid.

MODEL NO.	CAPACITY (GALLONS)	DIMENSIONS (INCHES)	LINER (OPTIONAL)
CN-R/R♦-32	30 - 36	23-1/4 OD x 29-3/4 H	CN/B-1827
CN-R/R♦-52	52	26-1/2 OD x 29-3/4 H	CN/B-1828
CN-R/R♦-55	55	26-1/2 OD x 36 H	CN/B-1829



ROUND RECEPTACLE - Expanded Steel

- Fabricated from a single piece of 3/4-#9 expanded steel (diamond holes) and reinforced with 10 ga. top and bottom rings and die-formed cross braces across the bottom providing holes for surface anchoring options. All welded construction, no assembly required.
- Available in 3 standard sizes, see chart below for details.
- Receptacle is coated with UV-stabilized thermo-plastic. Replace (◆) in model number with letter of desired color. See Page 56.
- **Optional:** Galvanized steel or rigid plastic liners. See Page 73.
- **Optional:** Trash and Recycling Lids. See Pages 68-71.
- **Optional:** Stationary mounts. See Page 74. For surface anchors see Page 126.

MODEL NO.	CAPACITY (GALLONS)	DIMENSIONS (INCHES)	LINER (OPTIONAL)
CN-R/D◆-32	30 - 36	23-1/4 OD x 29-3/4 H	CN/B-1827
CN-R/D◆-52	52	26-1/2 OD x 29-3/4 H	CN/B-1828
CN-R/D◆-55	55	26-1/2 OD x 36 H	CN/B-1829

Model CN-R/DW-32 Round Expanded Steel Trash Receptacle Holder for 32 gal. containers, brown thermo-plastic coated. Shown with optional **Model CN-PD/N-24PC1** green plastic dome recycling lid, and optional **Model M2/G** embedded mount pedestal base.



Model CN-R/DN-52 receptacle, optional **Model CN-PD/Y-27PC5** plastic dome lid, optional **M7/G** surface pedestal mount.



Shop Online at pilotrock.com

Join our e-newsletter for the latest information and promotions . . . go to pilotrock.com



ROUND RECEPTACLE - Cut Steel Plate

- Model **CN-R/SP2-32** will hold most 30-36 gallon liners.
- Formed using a single piece of 10 ga. cut steel plate.
- The base includes steel cross braces to reinforce the receptacle and to keep the liner inside up off the ground. Holes in these cross braces provide anchor points for surface mounting (anchor bolts not included).
- Colorful thermo-plastic coat finish. See Page 55.



Model CN-R/SP2/TA-32 cut steel plate receptacle, thermo-plastic coated gray, optional **Model CN-PD/U-24PC5** plastic dome recycling lid, optional **Model M2/G** embedded stationary mount, and **Model CN/B-1827** liner.

- **Optional:** Stationary mounts. See Page 74.
- **Optional:** Steel or rigid plastic liners. See Page 73.
- **Optional:** Plastic or steel lids. See Pages 68-71.

Model CN-R/SP2/TN-32 cut steel plate receptacle, thermo-plastic coated green, optional **Model CN-PD/N-24** plastic dome lid, optional **Model M3/G** surface mount, and **Model CN/B-1827** liner.



ROUND RECEPTACLE - *Cut Steel Plate* FEATURES RAIN BONNET & LOCKABLE DOOR

- **Model CN-R/SP3/CB-36D** steel receptacle includes a side open door for easy access to remove and empty the liner inside.
- Designed with 10 ga. steel "rain bonnet" to cover receptacle and optional liner.
- Fabricated using 3/16" thick 7 ga laser cut steel sheet. The base includes holes for surface anchor points (anchors not included). Welded into a single unit. No assembly required.
- Features two opposite side openings to deposit waste.
- Includes locking mechanism and key to prevent theft/vandalism.
- Includes (4) threaded adjustable levelers located equally around the base.
- Powder coat finish in your choice of colors. *See Page 52.*
- **Optional:** Steel or rigid plastic liners. *See Page 73.*
- **Optional:** ANC2-4 set of (4) 3/8" x 5" concrete surface screw anchors. *See Page 126.*



Detail of **Model CN-R/SP3/CN-36D** steel trash receptacle with rain bonnet showing the included adjustable base levelers.



Model CN-R/SP3/CB-36D steel trash receptacle with rain bonnet, finished in black powder coat. Shown with **Model CN/B-1827** rigid plastic liner.



Same receptacle with door open. Shown with **CN/B-1827** rigid plastic liner.

ROUND RECEPTACLE WITH DOOR - *Steel Strap*

- **Model CN-R/SS2-36D** steel strap receptacle with a side open door for easy access to remove and empty the liner inside.
- Fabricated using 1/8" thick x 2" wide steel vertical ribs. The flare top is reinforced with a 1" dia. steel tube ring. The base structure includes a steel flange ring and cross braces. These braces include holes for surface anchor points (anchors not included) or pedestal mounts. Welded into a single unit. No assembly required.
- Includes (4) threaded adjustable levelers located equally around the base ring.
- Base ring supports liner 2" off the ground for longer life.
- Powder coat finish in your choice of colors. *See Page 52.*
- **Optional:** Steel or rigid plastic liners. *See Page 73.*
- **Optional:** Trash or recycling lids. *See Pages 68-71.*
- **Optional:** Stationary mounts (M2 or M3). *See Page 74.*
- **Optional:** ANC2-4 set of (4) 3/8" x 5" concrete surface screw anchors. *See Page 126.*



Model CN-R/SS2/CR-36D round steel strap receptacle with door, finished in red powder coat.
Model CN-SDR/A-24 round plastic dome lid with square door.



Model CN-R/SS2/CB-36D round steel strap receptacle with door, finished in black powder coat. **Model T/CB-2410** flat steel lid with black powder coat finish and **CN/B-1827** rigid plastic liner.



Same receptacle with door open. shown with **Model T/CB-2410** flat steel lid with black powder coat finish and **CN/B-1827** rigid plastic liner.



AMHERST RECEPTACLE - Round or Square

- The **Amherst Series** receptacles feature all steel, all welded construction.
- The vertical and horizontal straps are fabricated from 10 ga. steel. Three horizontal bands and the integral steel tube around the top provide reinforcement. Powder coated finish. See Page 52. The receptacles are shipped fully assembled. Includes #CK-5 lid cable kit.
- The steel bottom braces include holes for surface anchors (not included). Optional elevated mounting posts (Models M7/G and M8/G) are available to secure the receptacles in place. See Page 74. All Amherst trash receptacles include four levelers.
- Two shapes:
 - **Model CN-AMR** is a traditional Round shape.
 - **Model CN-AMQ** is a contemporary Square shape.



Model CN-AMQ/CB-32 square steel receptacle, black powder coated finish. Shown with optional **Model CN-PQD/A-24** gray square plastic dome lid.



- Both receptacles will hold up to a 36-gallon capacity liner (optional).
- Both receptacles have multiple lid choices. See Pages 68-71.
- **Optional:** Steel or rigid plastic liners. See Page 73.
- **Optional:** Steel bands around AMR and AMQ provide an area for your custom vinyl decal signage. See Page 72.



Model CN-AMR/CR-32 round steel receptacle, red powder coated finish. Shown with optional **Model CN/N-3031PC5** green plastic recycling lid, and optional **CN/B-1827** liner.

Model CN-AMR/CR-32 round steel receptacle, red powder coated finish. Shown with optional **Model CN-SDR/U-24** blue plastic dome lid.

ROUND RECEPTACLE - Vertical Wave Steel Strap

- **Model CN-R/SS3-36** trash receptacle is designed to hold most available 30-36 gallon liners. Dimensions: 32" tall x 29" OD x 22-3/4" ID.
- Fabricated using 1/8" thick x 1" wide steel vertical ribs with a die formed wave pattern. The top is finished and reinforced with a steel tube ring of 1" OD x 14 ga. wall steel tube. The base structure includes a 10 ga. steel ring and cross braces with holes to provide anchor points for surface mounting (anchor bolts are not included). Welded into a single unit, no assembly required.
- Four threaded adjustable levelers located equally around the base ring.
- Thermo plastic coat finish in your choice of colors. See Page 55.
- **Optional:** Steel or rigid plastic liners. See Page 73.
- **Optional:** Trash or recycling lids. See Pages 68-71.
- **Optional:** Anchor kit #ANC3-4 (four 3/8" x 3" concrete screw anchors) for hard surface mounting. See Page 126.
- **Optional:** Matching Planter (see Page 87).

Model CN-R/SS3/TN-36 receptacle, green thermo-plastic coat finish, shown with optional **Model T/CN-2410** flat steel lid with green powder coat finish, and optional **CN/B-1827** liner.



TRASH AND RECYCLING RECEPTACLES - Lumber & Recycled Plastic

- **Model TRH** Trash Receptacle Holders are an attractive way to collect trash or recyclables.
- **Model TRH** Trash Receptacle Holders are available in two sizes:
 - **Model TRH-32** (22-3/8" ID) holds a 30- to 36-gallon capacity can or liner.
 - **Model TRH-55** (25-3/8" ID) holds a 55-gallon barrel or liner.
- **Standard:** 2" x 4" (nom.) slat material: pressure treated #1 southern yellow pine.
- **Optional:** 100% recycled plastic slats. *See Page 54.*
- TRH frames include a top and bottom ring; both rolled using 10 ga. steel with a formed flange for strength. The base ring is reinforced with die-formed cross braces. These braces also serve to keep the container inside the TRH up off the ground. Each ring is hot dip galvanized after fabrication. Galvanized fasteners included.



Model TRH/G-32PN24 receptacle with **Model CN-PD/Y-27** lid, on **Model M3/G** surface pedestal mount.



Model TRH/G-32PA24 receptacle with **Model CN/N-3031PS** paper recycling lid.

Model TRH/G-55TP24 receptacle with **Model CN-PD/W-27** lid.

- **Optional:** Steel or rigid plastic liners. *See Page 73.*
- **Optional:** Trash and recycling lids. *See Page 68-71.*
- **Optional:** Stationary mounts. *See Page 74.*
For surface anchors, see Page 126.
- **Optional:** Powder coat finish on frame rings. *See Page 52.*
- **Optional:** Custom engraving on recycled plastic slats. *See Page 25.*



Model TRH/G-55PC24/SO receptacle, cedar colored plastic slats, with **Model TG-27X** flat lid.

SIDE OPENING TRASH KIT

- **Model TRH-55/SO** receptacle includes one side opening to deposit trash into a 30-32 gallon liner. Kit includes: Model TG-27X flat lid, a hinge/hasp kit to attach the lid to top frame ring, one brass padlock to secure lid, and a 30-32 gallon plastic trash can, galvanized finish on steel components.
- **Model TRH-55/SO2** features two opposite side openings to deposit waste.
- Slats available in treated pine or 100% recycled plastic in a choice of colors. *See Page 54.*
- **Optional:** Powder coat finish on frames and lid in choice of colors. *See Page 52.*

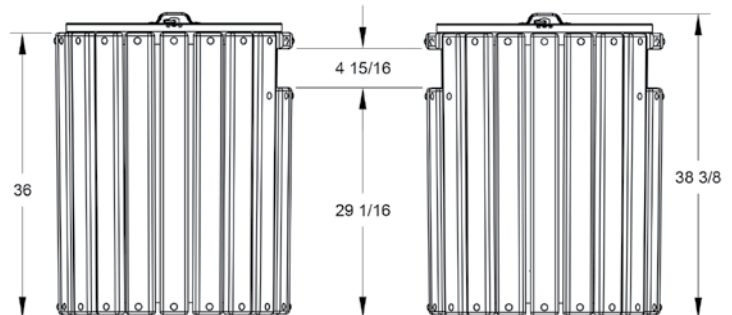

Model TRH-55/SO

Model TRH-55/SO2 features 2 side openings.



TILTING TRASH RECEPTACLE

- Perforated steel basket has approximate 52 gallon capacity. Use your disposable garbage bags inside. No separate liner required.
- Support yoke is single piece 2-3/8" OD steel pipe. Twin pedestal support can withstand public exposure. The basket is suspended about 13" off the ground surface for convenient access for the public and maintenance crew.
- No heavy vertical lifting! Basket weight is supported by the yoke. Just tip it forward and remove the trash bag. The 60-degree tilt makes it easy to slide the trash bag out.
- Durable, commercial grade spring-loaded pin holds the basket in the vertical collection position and in the tilted unloading position. Easy one person operation.



Model CN-TR/P/CN-52RN Tilting Trash Receptacle, shown with lid removed and locked at 60 degree tilt position for easy trash bag removal.



- The solid band around basket provides a visible area for custom signage - cut into the basket or use adhesive vinyl decals.
- The yoke framework is powder coated. The perforated basket is thermo-plastic coated. Matching colors are standard. For color choices see Pages 52 & 57.
- **Standard:** Embedded post installation – **Model CN-TR-52.**

- **Optional:** Surface mount bolt down base plate – **Model CN-TR/P-52** (includes two sets #ANC1-4 concrete anchor bolts).
- **Optional:** Band-It trash bag loop to hold your trash bag in the basket. See Page 72.
- **Optional:** Your choice of plastic or steel trash or recycling lids. See Pages 64-67.
- **Optional:** #CN/B-1827 rigid plastic liner, 36 gal. See Page 73.
- **Optional:** 2-part aluminum cover caps for **Model CN-TR-52** with embedded post installation. See Page 25.

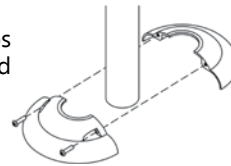

Model CN-TR/CN-52RN Tilting Trash Receptacle, green powder coat frame finish and green thermo-plastic coat basket finish, shown with optional **Model CN-PD/N-24** green plastic dome lid. Shown in locked vertical position for collecting trash. Provide your own disposable trash bag liner.

- Two shapes. Two sizes.
- **ROUND** with dome top, 42 gal. capacity.
- **SQUARE** with square top, 32 gal. capacity.
- Complete set: includes outer base, top and inside liner.
- Rotationally molded polyethylene plastic has solid color molded in. Won't fade, dent or chip. Durable, heavy weight material. Round unit weighs 36 lbs., square shape weighs 29 lbs. Made in USA with recycled plastic and is 100% recyclable.
- Four molded in handles for easy use. Maintenance free plastic door hinge. Self-closing door fits tightly to keep insects out. Not affected by wind.
- Signage – outer base unit includes flat panels where you can apply your signage (not included).
- **8 BOLD Solid Colors:** Blue, Green, Brown, Black, Red, Yellow, Orange, White. Base and top are same color.

KOLORCANS



Model CN-S7101A/Y round receptacle in yellow color.



Model CN-S7801A/R square receptacle in red color.

Round Receptacle Model #	Square Receptacle Model #
Dome Top (Waste)	Square Top (Waste)
CN-S7101A/◆	CN-S7801A/◆
Replace (◆) in Model No. with letter indicating color choice. SOLID COLORS: Blue (U), Green (N), Brown (W), Black (B), Red (R), Yellow (Y), Orange (O), White (H).	



SQUARE RECEPTACLE - *Lumber & Recycled Plastic*

- **Model TRQ** receptacles hold 30 to 36-gallon capacity liners.
- Standard 2" x 4" (nom.) slat material: pressure treated #1 southern yellow pine.
- **Optional:** 100% recycled plastic slats. *See Page 54.*
- TRQ frames include a top and bottom ring, fabricated using 10 ga. steel with a formed flange for strength. The base ring is reinforced with die-formed cross braces. These braces also serve to keep the container inside the TRQ up off the ground. Each ring is hot dip galvanized after fabrication. Galvanized fasteners are included.



Model TRQ/G-32TP24 receptacle, treated pine slats, with optional **Model CN-PQD/B-27** lid.



Model TRQ/G-32PA24 receptacle, gray colored plastic slats, with optional **Model CN-PQD/N-27** lid.



Model TRQ/G-32PW24 receptacle, brown plastic slats, with optional **Model CN/B-1826** lid.

- **Optional:** Steel or rigid plastic liners. *See Page 73.*
- **Optional:** Trash and recycling lids. *See Pages 68-71.*
- **Optional:** Stationary mounts. *See Page 74. For surface anchors see Page 126.*
- **Optional:** Powder coat finish on frame rings. *See Page 52.*
- **Optional:** Custom engraving on recycled plastic slats. *See Page 25.*

SQUARE RECEPTACLE - *Expanded Steel*

- **Model CN-Q/D-32/2** will hold most 30-36 gallon liners.
- This container is formed using 4 flat expanded steel side panels, a base reinforced with cross braces, and a canopy top with large openings for easy trash disposal. Each piece is thermo-plastic coated. *See Page 56 for colors.* This unit is shipped knocked down. Galvanized fasteners included.



Model CN-Q/DU-32/2 receptacle, expanded steel, blue thermo-plastic coating. Shown with optional **Model CNG-2310C** galvanized steel trash can.

- The bottom panel keeps the liner off the ground. Anchor holes in cross braces can be used to secure receptacle in place (anchor bolts not included).
- **Optional:** Stationary mounts are available. *See Page 74. For surface anchors see Page 126.*
- **Optional:** Galvanized steel cans or rigid plastic liners are available. *See Page 73.*



Model CN-Q/DR-32/2 receptacle, expanded steel, red thermo-plastic coating. Shown with optional **Model CNG-2310C** galvanized steel trash can.



SQUARE FRAME RECEPTACLE

- **Model CN-Q-36** square frame receptacle with inlaid slats is the perfect site complement for the B130 Series Benches (page 4) and the T700 Series Picnic Tables (page 44). This square receptacle completes the ensemble. It also looks great on its own.
- Fabricated using 2" x 2" x 11 ga. square steel tube and steel channel for the four side panel frames. Each side frame is a welded single unit. Each corner post includes an anchor plate to secure the receptacle on site if desired (*anchor bolts not included*).
- All steel frame components have a powder coat finish in your color choice. See Page 52.
- Side panel inlay material: 1" x 4" (nom.) 100% recycled plastic in choice of colors. See Page 54. All inlaid planks are installed at the factory.
- Assembly of four side panels to each other is required on site.
- **Optional:** Steel or rigid plastic liners. See Page 73.
- **Optional:** Plastic or steel square lids. See Pages 68-71.
- **Optional:** #ANC3-4 set of (4) 3/8" x 3" concrete surface screw anchors. See Page 126.



(Left)
Model CN-Q/CB-36PA
Square Frame Receptacle with black powder coated frame and gray recycled plastic slats. Shown with **Model CN-PQD/A-24** plastic dome lid.

(Below)
Model CN-Q/CR-36PC, red powder coated frame, cedar colored recycled plastic slats, with **Model TQ/CR-2410** square flat lid with red powder coat finish.



Coordinate your outdoor spaces!
See page 44 for matching T700 tables and B130 benches on page 4.



(Above) **Model CN-Q/SS4/CB-36D** finished in black powder coat. **Model CN-PQD/A-24** square plastic dome lid and **CN/B-1827** rigid plastic liner.



(Right) **Model CN-Q/SS4/CY-36D** receptacle with yellow powder coat finish, door open. Shown with **Model TQ/CY-2410** flat steel lid and **CN/B-1827** rigid plastic liner.

SQUARE RECEPTACLE WITH DOOR

- **Model CN-Q/SS4-36D** square steel strap receptacle includes a side open door for easy access to remove and empty the liner inside.
- Fabricated using 1/8" thick x 2" wide steel vertical ribs. The flare top is reinforced with a 1" dia. steel tube ring. The base structure includes a steel flange ring and cross braces. These braces include holes for surface anchor points (anchors not included) or pedestal mounts. Welded into a single unit. No assembly required.
- Includes (4) threaded adjustable levelers located equally around the base.
- Base ring supports liner 2" off the ground for longer useful life.
- Powder coat finish in your choice of colors. See Page 52.
- **Optional:** Steel or rigid plastic liners. See Page 73.
- **Optional:** Plastic or steel square lids. See Pages 68-71.
- **Optional:** Stationary mounts (M2 or M3). See Page 74.
- **Optional:** ANC2-4 set of (4) 3/8" x 5" concrete surface screw anchors. See Page 126.



Shop Online at pilotrock.com

Join our e-newsletter for the latest information and promotions . . .
go to pilotrock.com

PLASTIC DOME LIDS

- Self-closing hatch
- Large opening
- Eight colors available

Cedar (C)	Brown (W)	Yellow (Y)	Green (N)	Gray (A)	Black (B)	Red (R)	Blue (U)
Replace (♦) in model number with letter indicating color choice							

Round



Model No.	I.D.	O.D.	Use with these Receptacle Holders
CN-PD/♦-27	27-1/4"	27-3/4"	TRH-32, TRH-55 (fits on top ring), CN-R/R-52, CN-R/D-52, CN-R/R-55, CN-R/D-55
CN-PD/♦-24	24"	24-1/2"	TRH-32, TRH-55 (fits on barrel inside), CN-AMR-32, CN-R/R-32, CN-R/D-32, CN-R/SS2-36, CN-R/SS2-36D, CN-EXP52, CN-R/SP2-32, CN-TR-52, CN-R/SS3-36, RA's

Square



Model No.	I.D.	O.D.	Use with these Receptacle Holders
CN-PQD/♦-27	27"	27-1/2"	TRQ-32
CN-PQD/♦-24	23-1/2"	24"	CN-AMQ-32, TRQ-32, CN-Q-36, CN-Q/SS4-36D

Square Door



Model No.	I.D.	O.D.	Use with these Receptacle Holders
CN-SDR/♦-24	24"	24-3/8"	TRH-32, TRH-55 (fits on barrel inside), CN-AMR-32, CN-R/R-32, CN-R/D-32, CN-R/SS2-36, CN-R/SS2-36D, CN-EXP52, CN-R/SP2-32, CN-TR-52, CN-R/SS3-36, RA's, 55 gal. barrel

STEEL DOME LIDS - Galvanized or Powder Coated

- Self-closing, spring loaded hatch
- Hot dip galvanized (/G)
- Optional powder coat finish



Model No.	I.D.	O.D.	Use with these Receptacle Holders
CN/♦-3434	21"	21-3/4"	Federal Duty 32 Gal. Galvanized Can, CNG-WHD32C
CN/♦-5555	23-3/4"	24-1/2"	TRH-32, TRH-55 (fits on barrel inside), CN-AMR-32, CN-R/R-32, CN-R/D-32, CN-R/SS2-36, CN-R/SS2-36D, CN-EXP52, CN-R/SP2-32, CN-TR-52, CN-R/SS3-36, RA's, 55 gal. barrel
CN/♦-2755	27-1/8"	27-1/4"	TRH-55, CN-R/R-52, CN-R/D-52, CN-R/R-55, CN-R/D-55
Replace (♦) in model number with (G) for galvanized or letter indicating powder coat color choice. See Page 52 for colors			

TIP: For all lids, confirm that the inside diameter of the lid (ID) will fit the outside



diameter (OD) of your receptacle. Some lids may fit more closely than others.



PLASTIC DOME LIDS FOR RECYCLING

- Dome is molded with solid door panel
- Two hole sizes
- Choice of eight colors
- Includes recycling decal. See below.

Cedar (C)	Brown (W)	Yellow (Y)	Green (N)	Gray (A)	Black (B)	Red (R)	Blue (U)
Replace (♦) in model number with letter indicating color choice							



Square Face

Model No.	Hole Dia.	I.D.	O.D.	Use with these Receptacle Holders
CN-SDR/♦-24PC1	3"	24"	24-3/8"	TRH-32, TRH-55 (fits on barrel inside), CN-AMR-32, CN-R/R-32, CN-R/D-32, CN-R/SS2-36, CN-R/SS2-36D, CN-EXP52, CN-R/SP2-32, CN-TR-52, CN-R/SS3-36, RA's, 55 gal. barrel
CN-SDR/♦-24PC5	4-3/8"			



Round Face

Model No.	Hole Dia.	I.D.	O.D.	Use with these Receptacle Holders
CN-PD/♦-27PC1	3"	27-1/4"	27-3/4"	TRH-32, TRH-55 (fits on top ring), CN-R/R-52, CN-R/D-52, CN-R/R-55, CN-R/D-55
CN-PD/♦-27PC5	4-3/8"			
CN-PD/♦-24PC1	3"	24"	24-1/2"	TRH-32, TRH-55 (fits on barrel inside), CN-AMR-32, CN-R/R-32, CN-R/D-32, CN-R/SS2-36, CN-R/SS2-36D, CN-EXP52, CN-R/SP2-32, CN-TR-52, CN-R/SS3-36, RA's
CN-PD/♦-24PC5	4-3/8"			



CN/N-3031PC5



CN/N-3031PS

PLASTIC CANOPY LID FOR RECYCLING - Collect Recyclable Cans and Paper

- Collect cans, bottles and paper for recycling.
- Single piece molded plastic lid is available in the popular green recycling color.
- Openings on both ends of the canopy.
- Twin vinyl trimmed openings are available in three sizes: 3" round, 4-3/8" round, and 2" x 7-1/2" slot.
- Includes two recycling decals. See below.

Model No.	I.D.	O.D.	Hole Dia.	Use with these Receptacle Holders
CN/N-3031PC1	24-1/8"	24-1/2"	3"	TRH-32, TRH-55 (fits on barrel inside), CN-AMR-32, CN-R/R-32, CN-R/D-32, CN-R/SS2-36, CN-R/SS2-36D, CN-EXP52, CN-R/SP2-32, CN-TR-52, CN-R/SS3-36, RA's, 55 gal. barrel
CN/N-3031PC5			4-3/8"	
CN/N-3031PS			2" x 7-1/2"	



DE-22



DE-23



DE-24



DE-34



DE-26

RECYCLING DECALS

The plastic recycling lids shown on this page each include a "Recycle" decal. The vertical decals are 4" x 6-1/4" tall; the horizontal decal is 2-1/2" x 8" wide. Please specify which decal you need for your collection program:

Model DE-22 "Cans Only" (we recommend 3" dia. hole)

Model DE-23 "Plastic Bottles Only" (we recommend 4-3/8" dia. hole)

Model DE-24 "Cans & Bottles Only" (we recommend 4-3/8" dia. hole)

Model DE-34 "Recycle Only" (use with any round hole size)

Model DE-26 "Paper Only" (for use on CN/N-3031PS lid only)

Custom Decals are available. Same size and colors. Minimum order (15) of same design.

FLAT STEEL TRASH AND RECYCLING LIDS

- Fabricated from 16 ga. galvanized steel. For standard galvanized finish replace (◆) in model number with "G".
- Optional powder coat available. For color choices see Page 52. Replace (◆) in model number with letter of desired color.
- Recycling Lid includes a vinyl-trimmed hole in choice of three sizes.
- Hinge and Hasp kits, Recycling Decals, and Lid Security Kits available. See Page 72.

Trash Can Lids (No Hole)



Model No.	I.D.	O.D.	Use with these Receptacle Holders
T◆-19X	19"	19-1/8"	30 Gal. barrel
T◆-22X	22"	22-1/8"	TRH-20
T◆-24X	24"	24-1/8"	TRH-32, TRH-55 (fits on barrel inside), CN-AMR-32, CN-R/R-32, CN-R/D-32, CN-R/SS2-36, CN-R/SS2-36D, CN-EXP52, CN-R/SP2-32, CN-TR-52, CN-R/SS3-36, RA's, 55 gal. barrel
T◆-27X	27-1/8"	27-1/4"	TRH-55 (fits on top frame ring), CN-R/R-52, CN-R/D-52, CN-R/R-55, CN-R/D-55

Trash Can Lid with 10" Spring-loaded Hatch



Model No.	I.D.	O.D.	Use with these Receptacle Holders
T◆-19	19"	19-1/8"	30 Gal. barrel
T◆-22	22"	22-1/8"	TRH-20
T◆-24	24"	24-1/8"	TRH-32, TRH-55 (fits on barrel inside), CN-AMR-32, CN-R/R-32, CN-R/D-32, CN-R/SS2-36, CN-R/SS2-36D, CN-EXP52, CN-R/SP2-32, CN-TR-52, CN-R/SS3-36, RA's, 55 gal. barrel
T◆-27	27-1/8"	27-1/4"	TRH-55 (fits on top frame ring), CN-R/R-52, CN-R/D-52, CN-R/R-55, CN-R/D-55

Recycling Lid with 3" Diam. Hole



Model No.	I.D.	O.D.	Use with these Receptacle Holders
T◆-22PC1	22"	22-1/8"	TRH-20
T◆-24PC1	24"	24-1/8"	TRH-32, TRH-55 (fits on barrel inside), CN-AMR-32, CN-R/R-32, CN-R/D-32, CN-R/SS2-36, CN-R/SS2-36D, CN-EXP52, CN-R/SP2-32, CN-TR-52, CN-R/SS3-36, RA's, 55 gal. barrel
T◆-27PC1	27-1/8"	27-1/4"	TRH-55 (fits on top frame ring), CN-R/R-52, CN-R/D-52, CN-R/R-55, CN-R/D-55

Recycling Lid with 4-3/8" Diam. Hole



Model No.	I.D.	O.D.	Use with these Receptacle Holders
T◆-22PC5	22"	22-1/8"	TRH-20
T◆-24PC5	24"	24-1/8"	TRH-32, TRH-55 (fits on barrel inside), CN-AMR-32, CN-R/R-32, CN-R/D-32, CN-R/SS2-36, CN-R/SS2-36D, CN-EXP52, CN-R/SP2-32, CN-TR-52, CN-R/SS3-36, RA's, 55 gal. barrel
T◆-27PC5	27-1/8"	27-1/4"	TRH-55 (fits on top frame ring), CN-R/R-52, CN-R/D-52, CN-R/R-55, CN-R/D-55

Recycling Lid with 5-7/8" Diam. Hole



Model No.	I.D.	O.D.	Use with these Receptacle Holders
T◆-22PC6	22"	22-1/8"	TRH-20
T◆-24PC6	24"	24-1/8"	TRH-32, TRH-55 (fits on barrel inside), CN-AMR-32, CN-R/R-32, CN-R/D-32, CN-R/SS2-36, CN-R/SS2-36D, CN-EXP52, CN-R/SP2-32, CN-TR-52, CN-R/SS3-36, RA's, 55 gal. barrel
T◆-27PC6	27-1/8"	27-1/4"	TRH-55 (fits on top frame ring), CN-R/R-52, CN-R/D-52, CN-R/R-55, CN-R/D-55

TIP: For all lids, confirm that the inside diameter of the lid (ID) will fit the outside



diameter (OD) of your receptacle. Some lids may fit more closely than others.



STEEL LIDS

T/◆-2410 Flat
T/◆-2710



- 16 ga. formed steel construction
- **Optional:** choice of powder coat colors. *See Page 52.* Replace (◆) in model number with letter indicating color choice.
- 10" diameter hole

- **Optional:** 12" diameter bolt-on rain cover, add "R" to model number.
- **Optional:** 6" diameter ashtray in rain cover, add "A" to model number.
- Assembly required for rain cover and ash tray options.

T/◆-2410R
T/◆-2710R
12" dia. Rain Cover



Model No.	I.D.	O.D.	Use with these Receptacle Holders:
T/◆-2410 T/◆-2410R T/◆-2410A	24"	24-1/8"	TRH-32, TRH-55 (fits on barrel inside), CN-AMR-32, CN-R/R-32, CN-R/D-32, CN-R/SS2-36, CN-R/SS2-36D, CN-EXP52, CN-R/SP2-32, CN-TR-52, CN-R/SS3-36, RA's
T/◆-2710 T/◆-2710R T/◆-2710A	27-1/8"	27-1/4"	TRH-55 (fits on top of frame ring), CN-R/R-52, CN-R/D-52, CN-R/R-55, CN-R/D-55

T/◆-2410A
T/◆-2710A
6" dia. Ash Tray

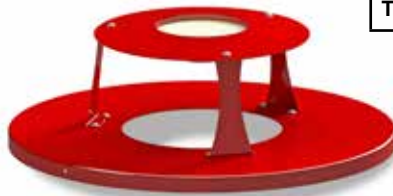

Model No.	I.D.	O.D.	Use with these Receptacle Holders:
TQ/◆-2410 TQ/◆-2410R TQ/◆-2410A	23-5/8"	23-3/4"	CN-AMQ-32, TRQ-32, CN-Q-36, CN-Q/SS4-36D

TQ/◆-2410
Flat



TQ/◆-2410R
12" dia. Rain Cover



TQ/◆-2410A
6" dia. Ash Tray



MOLDED PLASTIC LIDS



Round

Model No.	I.D.	O.D.	Center Hole Diameter	Use with these Receptacle Holders:
CN/B-1825	24-3/8"	25"	10"	TRH-32, TRH-55 (fits on barrel inside), CN-AMR-32, CN-R/R-32, CN-R/D-32, CN-R/SS2-36, CN-R/SS2-36D, CN-EXP52, CN-R/SP2-32, CN-TR-52, CN-R/SS3-36, RA's, 55 gal. barrel
CN/B-55FT	24"	24-3/4"	15"	

Color: Black only



Square

Model No.	I.D.	O.D.	Center Hole Diameter	Use with these Receptacle Holders:
CN/B-1826	23-3/8"	24"	10"	CN-AMQ-32, TRQ-32, CN-Q-36, CN-Q/SS4-36D

Color: Black only



Canopy

Model No.	I.D.	O.D.	Use with these Receptacle Holders:
CN/B-3030	24-1/8"	24-1/2"	TRH-32, TRH-55 (fits on barrel inside), CN-AMR-32, CN-R/R-32, CN-R/D-32, CN-R/SS2-36, CN-R/SS2-36D, CN-EXP52, CN-R/SP2-32, CN-TR-52, CN-R/SS3-36, RA's, 55 gal. barrel

Color: Black only

HASP AND HINGE KITS



Model HHG-1:
Hinge/Hasp Kit to mount Model T-19 and T-24 lids to 30- or 55-gallon barrels.



Model HHG-2:
Hinge/Hasp Kit to mount Model T-22, T-24, and T-27 lids to top frame ring of all TRH receptacles.

Made from galvanized steel. Zinc plated fasteners included. Optional PL-1 brass padlock through hasp prevents theft of contents and disposal of other trash. For use with Model T-19, T-22, T-24, and T-27 flat steel trash and recycling lids.



HHG-5 Hinge Hasp Kit

- Model HHG-5 is a unique hinge design that allows the lid to be fully opened but it remains permanently attached to the barrel. For use with our T-19 and T-24 steel lids on Page 66 and 30- or 55-gallon barrels.
- **Features:** Galvanized finish, includes all fasteners and barrel edge spacer.
- **Optional:** Lid, barrel and #PL-1 brass padlock.

LID SECURITY KITS



CK-1 Chain Kit
40" x 1/8" Galvanized welded steel chain with 2 equal leg "S" hooks (Used only with RPP posts)



CK-5 Cable Kit
36" of Plastic coated 1/8" steel cable with 2 aluminum crimp sleeves



CK-6 Multiple Application Chain Kit,
24" x 1/8" Galvanized welded steel chain with 1 eyescrew, 2 equal leg "S" hooks, and 2 unequal leg "S" hooks



WSK-1 Web Strap Kit
1" x 14" of woven nylon strap with snap hook, grommet hole, 1 D-ring and 1 "S" hook

BAND-IT PREMIUM ELASTIC TRASH CAN LOOP



- Holds plastic trash bag in place with elastic band around the top edge of the liner.
- No more mess when a plastic bag falls down inside the can. Fits metal and plastic cans from 20- to 55-gallon sizes.
- Easy to install. Reusable.
- Sold in case lots only-36 individually packaged Band-Its per case.
- Order Item **#CN-BANDIT44455**.
- Note: We do not sell the plastic trash bags.

RECYCLING DECALS FOR LIDS

Self-adhesive decals, 3" x 15", green letters on white vinyl background for identification of intended use for recycling units.

- Model DE-1:** "CANS ONLY"
- Model DE-2:** "PAPER ONLY"
- Model DE-3:** "PLASTIC ONLY"
- Model DE-4:** "GLASS ONLY"
- Model DE-5:** "ALUMINUM ONLY"
- Model DE-11:** "TRASH ONLY"
- Model DE-19:** "RECYCLE ONLY"

Custom Decals Available.

1. Same size and colors as above but with your custom message.
2. Design a custom decal specifying size, shape, color and message.
3. A minimum quantity may apply.



DE-1



DE-3



DE-5



DE-2



DE-4



DE-11





DE-19



Model DE-11 "TRASH ONLY"
decal shown on a BPRT1-36 bear proof receptacle.

	Regular Duty Galvanized Steel Cans					
	Model No.	Capacity	O.D.	Height	Weight	Use with these Receptacle Holders
	CNG-2310C without lid. CNG-2310CL includes lid	31 gal.	20-1/2 in.	27 in.	10 lbs. 12 lbs.	CN-R/SS2-36, CN-R/SS2-36D, CN-R/SP2-32, CN-R/R-32, CN-R/D-32, CN-Q/D-32/2, CN-Q-36, CN-Q/SS4-36D, TRH-32, TRQ-32, TRH-55/SO, CN-AMR-32, CN-AMQ-32, CN-R/SP3-36D, CN-R/SS3-36, RPP Post, CH-4, RA Arrays, CN-VDT-32, HCB-1
Lighter weight, 27 ga. galvanized steel cans						

	Heavy Duty Rigid Plastic Liners						
	Model No.	Capacity	O.D.		Height	Weight	Use with these Receptacle Holders
			Top	Bottom			
	CN/B-1827	36 gal.	21 in.	18 in.	28 in.	10 lbs.	CN-R/SS2-36, CN-R/SS2-36D, CN-R/SP2-32, CN-R/R-32, CN-R/D-32, CN-Q/D-32/2, CN-Q-36, CN-Q/SS4-36D, TRH-32, TRQ-32, TRH-55/SO, CN-AMR-32, CN-AMQ-32, CN-EXP52, CN-TR-52, CN-R/SP3-36D, CN-R/SS3-36, RA Arrays, BPRT Series
CN/B-1828	52 gal.	25 in.	22 in.	29 in.	11 lbs.	CN-R/R-52, CN-R/D-52	
CN/B-1829	55 gal.	23-5/8 in.	20-7/8 in.	35 in.	14 lbs.	CN-R/R-55, CN-R/D-55, TRH-55	

	Rigid Plastic Liner					
	Model No.	Capacity	O.D.	Height	Weight	Use with these Receptacle Holders
CN-4132C	30 gal.	23 in.	27 in.	5 lbs.	CN-R/SS2-36, CN-R/SS2-36D, CN-R/SP2-32, CN-R/R-32, CN-R/D-32, CN-Q/D-32/2, CN-Q-36, CN-Q/SS4-36D, TRH-32, TRQ-32, TRH-55/SO, CN-AMR-32, CN-AMQ-32, CN-R/SP3-36D, CN-R/SS3-36, RA Arrays, BPRT Series	

	Federal Duty Galvanized Steel Cans					
	Model No.	Capacity	O.D.	Height	Weight	Use with these Receptacle Holders
	CNG-WHD32C without lid. CNG-WHD32CL includes lid	32 gal.	21-1/4 in.	26-1/4 in.	19 lbs. 22 lbs.	CN-R/SS2-36, CN-R/SS2-36D, CN-R/SP2-32, CN-R/R-32, CN-R/D-32, CN-Q/D-32/2, CN-Q-36, CN-Q/SS4-36D, TRH-32, TRQ-32, TRH-55/SO, CN-AMR-32, CN-AMQ-32, CN-R/SP3-36D, CN-R/SS3-36, RPP Post, CH-4, RA Arrays, CN-VDT-32, HCB-1
Heavy 23 ga. galvanized (ASTM A123 or A653) steel cans. Meets Fed. Spec. NSN:7240-00-160-0440 and 0441						



Combine benches, planters and trash receptacles to create beautiful outdoor spaces!

MOUNTS FOR TRASH RECEPTACLES - *Elevated*

- A 2-3/8" OD steel pipe base post, welded to structural steel angle cross arms, bolts to the cross braces in the receptacle base ring (fasteners included).
- Elevated Pedestal Mounts supports receptacles 8" above ground.
- Standard hot dip galvanized finish (/G).
- Optional powder coat finish. *See Page 52.*

Embedded Pedestal Mount The post is embedded into a concrete footing.	Model No.	Support	Use with these Receptacle Holders	Model No.	Surface Pedestal Mount Includes a welded 1/4" x 8" x 8" base plate anchored to surface (anchor bolts not included). <i>See Page 126.</i>
	M2	3 Crossarms 	TRH-32, TRQ-32, CN-R/R32, CN-R/D-32, CN-Q/D-32/2, CN-R/SS2-36, CN-R/SS2-36D, CN-R/SP2-32, CN-R/SS3-36, CN-Q/SS4-36D	M3	
	M8	4 Crossarms 	TRH-55, CN-AMR, CN-AMQ, CN-R/D-52, CN-R/D-55, CN-R/R-52, CN-R/R-55	M7	

MOUNTS FOR TRASH RECEPTACLES - *Ground Level*

- Seasonal Anchors for ground level installation. Four black enamel (/B) steel rods install through holes in cross braces of bottom frame ring and into ground. Allows for relocation of receptacle.

Seasonal Ground Level Mount	Model No.	Receptacle Mount	Use with these Receptacle Holders	Permanent Surface Anchoring
	M6/B	Steel Rods	TRH-32, TRH-55, TRH-55/SO, TRQ-32, CN-AMR, CN/AMQ, CN-EXP52, CN-Q/D-32/2, CN-R/R-32, CN-R/D-32, CN-R/SP2-32, CN-R/SS2-36, CN-R/SS3-36, CN-R/R-52, CN-R/D-52, CN-R/R-55, CN-R/D-55, CN-R-SS2-36D, CN-Q-SS4-36D Included with RA Arrays.	 TRH and TRQ receptacle base frames include (3 or 4) 9/32" dia. holes in flange to allow anchoring to a concrete surface using 1/4" x 2-1/4" concrete screws. Anchor bolts are not provided. NOTE: use same size anchors for P-10 planters.



SMOKER'S STACK

- All steel construction – won't melt or burn.
- Remove cigarette and cigar waste from view. Convenient size opening accepts all kinds of tobacco waste, but restricts deposit of other trash.
- Heavy gauge all steel construction will resist vandalism. Can be used in remote park and trail locations and in any public setting. Stands 40" tall. Includes decal identification.
- Two piece set includes: Square outer mounting post with bolt down base plate (concrete anchor bolts included); Round inner collection tube which lifts out to empty waste. A recessed set screw locks collection tube inside post and deters vandals. Requires allen wrench (included) to remove.
- Powder coated finish. *See Page 52 for colors.*

Model SS/P/CY-1
Smoker's Stack, base plate install, powder coated yellow.

Easy removal of inner Collection Tube.



TRASH CAN HANGER - *Recycled Plastic Post*

- Massive 6" x 6" (nom.) x 5 ft. long post, buried 2 ft. into ground to provide solid base.
- Post and hangers support trash cans above ground. Optional trash cans available. *See Page 73.*
- **Model RPP** Post is 100% recycled plastic. *See Page 54.* Plastic post is reinforced with molded-in steel pipe.
- Post kit can be equipped to hang 1 or 2 cans. (Specify when ordering.) Mounting hardware (base plate and J-hook) is formed from 3/16" steel, hot dip galvanized. Post kit includes chain kit to secure trash can lid to can base plate. All galvanized lag bolts provided. Attach support hardware to accommodate cans of various sizes.
- Post can hold up to 4 trash cans by ordering additional hardware kits (Model WP/G-H) and chain kits (Model CK-1).



(Above) **Model RPP/W-2**, brown recycled plastic post, hardware for 2 (optional) cans.

Model	Post Material	Includes hardware for	Optional Additional hardware
RPP/◆-1	Recycled Plastic	1 Can	To mount additional cans order (1) #WP/G-H hardware kit and (1) #CK-1 Chain Kit for each can.
RPP/◆-2		2 Cans	

Replace (◆) in model number with letters indicating color choice. *See Page 54.*



TRASH CAN HANGER - *Steel Post*

- **Model CH-4** Trash Can Hanger provides support for up to 4 steel trash cans.
- Central post is 1-7/8" OD steel pipe. Installs into a concrete footing.
- Steel handle hooks and bottom supports are welded to adjustable collars. The set screws in these collars allow you to adjust their positions to accommodate cans of various capacities and styles.
- Hot dip galvanized finish is standard (Model CH/G-4).
- **Optional:** Powder coat finish available. *See Page 52.*
- **Optional:** Trash cans available. *See Page 73.*
- **Optional:** Model CK-1 chain kit to secure can and lid to post. *See Page 72.*

Model CH/G-4 Trash Can Hanger. Shown with optional trash cans **Model CNG-2310CL**.

Complete Your Outdoor Space With . . .



Charcoal Grills



Lantern Poles



Campfire Rings



Wayfinding Signs

RECYCLING ARRAYS - RA Series

Provide a focal point for recycling and trash collection

- Recycling Arrays use the TRH-32 Trash Receptacle Holder as the basic module. *See Page 64.*
- Recycling Arrays come in three configurations, all with a center anchor post.

1-Module: Model RA1/G-P♦
uses a single TRH-32 receptacle.

RA-1

2-Module: Model RA2/G-P♦
uses two TRH-32 receptacles.

RA-2

3-Module: Model RA3/G-P♦
uses three TRH-32 receptacles.

RA-3

- The 4" x 4" (nom.) sq. center post of recycled plastic is the array focal point and is embedded into a concrete footing to secure the array in place. Modules bolt to the center post (and to each other for the 3-module array). Provided ground anchors, driven through holes in the base frame rings, can additionally anchor and secure the array structure.

- Each module includes galvanized steel frame rings and 1" x 4" (nom.) slats of 100% recycled plastic. *See Page 54 for colors* (replace "♦" with letters indicating color choice).

- **Optional:** Model TG-24 Recycling Lids can be used to collect a variety of recyclables. Our recycling decals let you identify what each module is used for (*see Page 72*).

- **Optional:** Other trash can covers and dome lids can also be used to add to the versatility of the array. *See Pages 68-71.*

- **Optional:** Complete the Array with a selection of metal or plastic liners. *See Page 73.*

- **Optional:** Band-It trash bag loop to hold your trash bag in place. *See Page 72.*



Model RA3/G-PA 3-module recycling array, gray recycled plastic post and slats. Shown with optional **Model TG-24** galvanized steel recycling and trash lids, lid decals, and padlocks.



Model RA2/G-PW 2-module recycling array, brown recycled plastic post and slats. Shown with optional **Model TG-24** galvanized steel recycling lids and lid decals.



A wide variety of plastic or steel dome and flat lids is available. Add recycling decals to equip your Recycling Array to collect recyclables or trash or both at the same time.

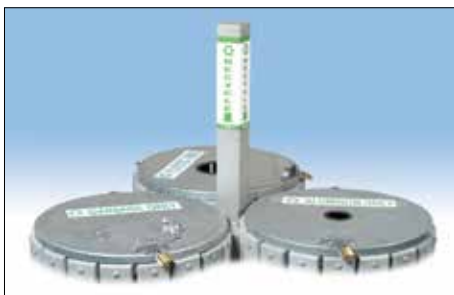

Model RA3/G-PC 3-module recycling array in cedar colored plastic with optional **Model CN-PD/N-24PC** green recycling lids. Also shown is optional engraved letters with green resin fill (*see Page 26*).



WASTE & RECYCLING



Pilot Rock® - Pet Waste Collection Station

The complete Pilot Rock Pet Waste Station Model PWS-D006 includes:

Steel post, sign and sign bracket, aluminum bag dispenser, aluminum waste can, 50 waste can liner bags, 400 waste collection bags, all assembly hardware and instructions. Station installed is 72 in. tall, 14 in. wide.

Reorder Bags: You will want to keep both bags on hand for quick refills.

Pet Waste Roll Bags:

Fits any dispenser. Size: 8" wide, 13" long. 200 bags per boxed roll. 10 boxes per case. Case weight = 14 lbs.

Order Case #PWS-D001

Waste Can Liner Bags:

1.55 mil. Size: 27.5" wide, 29" long, black, 50 bags per box, 4 boxes per case.

Case weight = 19 lbs. **Order Case #PWS-D002**



Sign: #PWS-D008

10 in. wide, 12 in. tall, aluminum, white/forest green powder coat finish.

Bag Dispenser: #PWS-D003

No rust aluminum fabrication with forest green powder coat finish, screen printed signage, lockable, three dispensing openings to hold three 200 count boxes of bags, plus room to store two extra boxes of bags, 1000 bag total capacity.

Steel Post:

Two-section solid steel, 1 in. standard hole spacing, galvanized finish, 84 in. assembled length, tapered end for easy installation.

Waste Can: #PWS-D004

No rust aluminum fabrication with forest green powder coat finish, self closing lid, 11 gallon capacity, built in clamps hold liners in place.



Part Number	Description
PWS-D006	Complete Pet Waste Station
PWS-D003	Pet Waste Roll Bag Dispenser Only
PWS-D001	Pet Waste Bags on a Roll Case: 10 Boxes, 200 bags per box
PWS-D002	Waste Can Liner Bags Case: 4 boxes, 50 bags per box
PWS-D004	Waste Can Only
PWS-D008	Sign (Replacement)
Optional Waste Station (Not Shown)	
PWS-D022	Complete Pet Waste Station - Bags On A Card
PWS-D019	Bags On A Card Dispenser only
PWS-D021	Bags On A Card Refill, 9 1/2" W x 15" L, 1 case = 3200 bags
PWS-D999	MittN Bags On A Card Refill, 8" W x 12-1/2" L with 5" mitten pouch, 1 case = 2,000 bags. Will fit all bags-on-card header dispensers.

Check out our new line of Dog Park Products!
See Pages 78-79

DogiPot® - Pet Waste Collection System



The DogiPot® light weight, polyethylene pet waste removal stations are built to commercial quality standards for use everywhere dogs and their owners go.

The complete DogiPot® Pet Waste Station includes:

- Junior Bag Dispenser (400 litter bag storage capacity). Forest green color.
- Two rolls (200 bags each) of opaque green litter pick up bags.
- Trash Receptacle with Lid, 10 gallon size. Forest green color.
- One box (50 count) heavy duty liner bags.
- Signage: 18" x 12" aluminum Pet Waste sign, plus instruction signage.
- Fiberglass 4' to 8' telescoping mounting post. Assembly and mounting instructions.
- Order the Complete Pet Waste Station, **Model PWS-DOGI1010**.

- For areas where you have your own trash receptacles you can install just the litter bag dispenser. Pet owners can take a bag, use it as they exercise their pet, and dispose of it in the nearest trash receptacle.
- Order the DogiPot® Junior Bag Dispenser only, **Model PWS-DOGI1007-2** (includes two rolls of 200 bags each).

Order bag refills:

- **Model PWS-DOGI1402-10** Litter Pick Up Bags, 8" x 13" long, opaque green. 200 bags per box. Minimum order one case of ten boxes (2000 bags).
- **Model PWS-DOGI1404** Receptacle Liner Bags, 10 gal., opaque black, draw tape close, box of 50 bags.



Playgrounds For Dogs™

MODEL DPE-DOGI7522 Dogi-Jump Hoops



- Dog shaped, 3-level hoops, 22.5" ID.
- Welded steel component fabrication with Green thermoplastic coating.
- (2) in-ground mounting posts with powder coat finish.
- Can be surface mounted. Anchor bolts not included.
- Dimensions (installed): 80" wide x 42" tall. Weight: 80 lbs.

MODEL DPE-DOGI7731 Fire Hydrant



- Decorative fire hydrant is molded with unsaturated poly resin.
- Coated with Red poly urethane paint to seal out urine.
- (4) in-ground mounting j-rods are powder coated Red.
- Can be surface mounted. Anchor bolts not included.
- Dimensions (installed): 33" high x 15" wide.
- Weight: 29 lbs.

MODEL DPE-DOGI7523 3-Level Steel Jump Hurdles

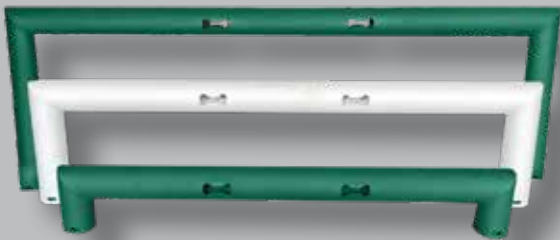

- (3) hurdles, 11 ga. x 3" OD steel tube.
- Textured powder coat finish: (2) green, (1) beige.
- (6) in-ground mounting posts with powder coat finish.
- Dimensions (installed): #1: 41" wide x 6" high; #2: 48" wide x 12" high; #3: 55" wide x 18" high.
- Weight: 90 lbs.

MODEL DPE-DOGI7511 Rectangular Bone Table

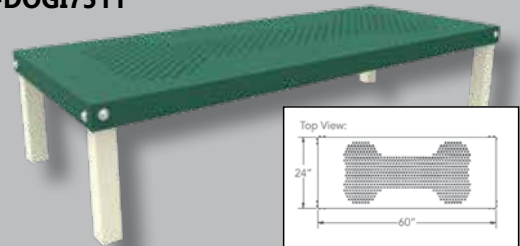

- Table is 11 ga. steel with perforated bone-shape artwork, with Green Ruffcoat™ protective slip resistant coating.
- (4) legs are 13 ga. 4x4 in. square steel tube, with beige powder coat finish.
- (4) in-ground mounting posts with powder coat finish.
- Dimensions (installed): 60" long x 24" wide x 12" high.
- Weight: 135 lbs.
- Holds up to 500 lbs. maximum.

MODEL DPE-DOGI7531 Dogi-Tunnel



- Aluminum tunnel is 36" ID x 46". long, with Green powder coat finish.
- (4) legs are 2" square steel tube with Beige powder coat finish.
- (4) in-ground mounting posts have powder coat finish.
- Dimensions (installed): 59" tall (at tail) x 44.5" wide x 46" long; 9" high at bottom of tunnel.
- Includes (1) tail and (2) ears.
- Weight: 210 lbs.

MODEL DPE-DOGI7521 Arched Stepping Bones

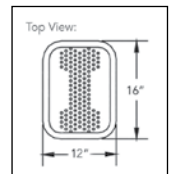

- (5) Steps are 12" x 16" wide, 11 ga steel with bone-shape artwork punched into each step.
- Steps are 12", 18" and 24" high and have Green Ruffcoat™ protective, slip resistant coating.
- 13 ga. 2.375" square steel tube framework with Beige powder coat finish.
- (3) in-ground mounting posts with powder coat finish.
- Can be surface mounted. Anchor bolts not included.
- Dimensions (installed): 84" wide x 16" deep x 24" tall.
- Weight: 155 lbs.
- Holds up to 200 lbs. maximum weight.

Products include in-ground mounting hardware. Follow manufacturer's installation instructions. All products must be securely installed in-ground or surface mounted to concrete (using your own hardware). This equipment is not intended for use by people. This equipment is solely intended and designed for dog use only. Warranty provided by Dogi-Pot: (2) years on fabrication, (5) years on Ruffcoat™ and thermoplastic coating. Made in the USA. DogiPot, Ruffcoat and "Playgrounds For Dogs" are trademarks of the DogiPot Company.

Dog Park Products . . . For People

Outfit your dog park with durable and comfortable site amenities for the people the dogs bring along. Many of our products can include custom artwork or signage. Here are just a few examples . . .



Model T214/G-4RR portable, blue powder coated steel frames, 4 ft. round table, perforated steel seats and top with dog paw art, thermoplastic coated in red color. See Pages 40-41 for more details.

Picnic Tables are a great addition to any dog playground site. Perforated Steel picnic tables . . . rectangular, square and round . . . can include your preferred dog art (*within the limits of material, perforating process, and size*). Contact us for more details.



Model SQT/G-4HT portable, hot dip galvanized steel frames, 4 ft. square table, perforated steel seats and top with dog paw art, thermoplastic coated in tan color. See Page 38 for more details.

Plenty of seating is always a necessity at any dog park. Our **Park Benches** offer many possibilities for dog parks. We can include custom art, plaques or signage in cut steel plate, perforated steel, recycled plastic and our Sign Bench.

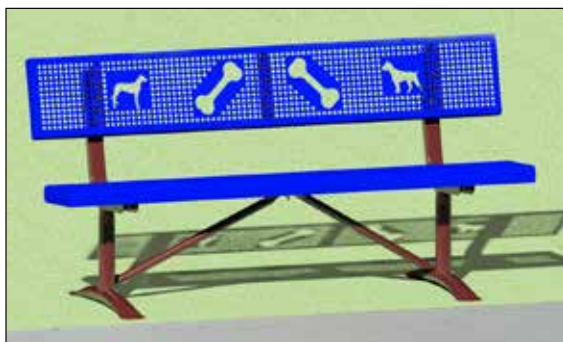

Model PCXB/CW-6HU12 portable/surface mount bench, brown powder coated steel frames, 6 ft., perforated steel seat and back with brown thermoplastic coating, custom artwork in backrest. See Pages 6-7 for more details.

Model B78/CA-6SP/TR has custom art laser cut in the steel contour seat, shown with gray powder coated frames, 6ft., red thermoplastic coated seat, surface mount. See Page 17 for more details.



Model CN-TR/P/CU-52RY elevated tilting trash receptacle, blue powder coated support yoke, 52 gallon perforated steel trash basket with yellow thermoplastic coating, custom artwork. Shown with optional trash collection lid. See Page 65 for more details.

Check out our Pet Waste Stations and Products!
See Page 77

There is never a shortage of waste in a dog playground site. To keep your dog park clean you will need **Trash Receptacles**. We have many to choose from, offering a selection of sizes, materials, colors and lids. Here are two that easily accommodate dog park art.

Model CN-R/RA-32 trash receptacle, perforated steel with custom artwork, gray thermoplastic coating, 32 gallon capacity. Shown with optional liner and **Model T/CB-2410R** lid. See Page 60 for more details.



CERTIFIED BEAR RESISTANT FOOD STORAGE LOCKERS

These Food Storage Lockers have been designed ... and tested ... to keep bears out. The un-bear-able features include:

Construction: The top, sides and door panels are all fabricated using heavy 12 ga. steel plate. The bottom panel is 12 ga. pre-galvanized steel. The corner braces/leg posts are 12 ga. steel formed channels nested inside the formed channel side panel wraps. This design assembly creates strength and rigidity for the box. All welded assembly. Only the galvanized bottom panel is bolted in.

Door Features: Full swing doors ride on heavy gauge, stainless steel, full-length piano hinges. Doors included 2-4 latch points for extra security. The latch door is reinforced with a steel angle. The doors can be opened with one hand and comply with ADA guidelines for reach and operability. Doors are easy to swing closed. For safety, the door latch can be disengaged from inside.



Model BPFL/CNT-30 Bear Resistant Food Locker with textured green powder coat finish. 30 cu. ft capacity.



Hooks cut into top support channel inside the locker hold bags for access and organizing supplies.



Two **Model BPFL/CUT-15** Bear Resistant Food Lockers with textured blue powder coat finish stacked to save space with a smaller footprint. 15 cu. ft capacity each for a total of 30 cu. ft. Turn them in opposite directions to serve two campsites.

More Features:

- Four leveling feet so you can adjust for an uneven surface.
- Set of four 1/2" x 5" concrete screw anchors (#ANC5-4).
- Locker Ceiling is reinforced with formed steel channel that includes hooks for hanging packages.
- Wide doors provide easy access for large coolers.
- Room inside the locker to open the cooler lid without lifting it out.
- Air louvers in back panel provide ventilation but restrict insect access.
- A galvanized steel cover over the inside latch prevents contents inside from interfering with the latch operation from outside.
- Doors can be locked closed. Padlock not included.
- **Optional:** "Food Storage" decal #DE-36/2.
- **Finish:** Textured powder coat finish available in five colors: brown (/CWT), green (/CNT), black (/CBT), speckled tan (/CTT) and blue (/CUT). See Page 53.
- Pre-galvanized steel bottom panel is not painted.



Model BPFL/CWT-25 Bear Resistant Food Locker with textured brown powder coat finish. 25 cu. ft capacity.

Model	IGBC Cert. No.	Inside Capacity (Cu. Ft.)	Number of Doors	Latch Points per Door	Locker Box Outside Dimensions HxWxD (in.)	Overall Height (in.) (levelers retracted)	Anchor Kit Included
BPFL/◆-15	5104	15	1	2	33 x 26 x 34-1/2	40-3/8	ANC5-4
BPFL/◆-25	5123	25	2	2	33 x 47-3/4 x 30-1/2		
BPFL/◆-30	5105	30	2	2	33 x 47-3/4 x 37-1/2		
BPFL-D/◆-30	5258	15 (per compartment)	2	2	33 x 49-3/8 x 37-1/2	58	
BPFL-T/◆-18	5263	9 (per compartment)	2	1	41-3/4 x 25-3/4 x 35-3/4		

Replace "◆" with letters indicating color choice; Brown (CWT), Green (CNT), Black (CBT), Blue (CUT), Speckled Tan (CTT).

BPFL-D FOOD LOCKER WITH CENTER WALL

- **Optional:** Model BPFL-30 food locker can be equipped with a center dividing wall which creates two equal 15 cu. ft. compartments, creating Model BPFL-D-30.
- Each compartment has its own door with latch and two latch points.
- Each door can be padlocked closed separately. Padlock not included.
- **Optional:** "Food Storage" decal #DE-36/2.



Model BPFL-D/CTT-30 Bear Resistant Food Locker, with center dividing wall, textured speckled tan powder coat paint finish, two individual 15 cu. ft. compartments.

BPFL EMBEDDED POST MOUNT

Optional installation method for BPFL Food Lockers



- Alternate Installation for BPFL Food Lockers
- If you don't have a concrete pad to anchor your Food Lockers to, this embedded post installation offers you an alternative.
- 3-1/2 in. OD x 61-1/4 in. long post is embedded into a concrete footing (min. recommended 12 in. dia. x 36 in. deep).
- The center back of the Food Locker is attached to this post.
- All hardware is included.
- The ground surface should be as level as possible.
- Black paint finish on post.
- **NOTE:** This installation method has not been tested/certified by the IGBC.
- Not available for the BPFL-T-18 Trail Side Locker.

Model BPFL/CB-POST1 alternate food locker installation method.

BPFL TRAIL SIDE LOCKER

- **Model BPFL-T-18** provides smaller lockers to temporarily store food and other gear you don't want to carry while hiking the trails.
- Two compartments per unit. Each compartment provides 9 cu. ft. of storage (20" H x 25-1/4" W x 32-1/4" D) for a total of 18 cu. ft. – large enough to hold backpacks, small coolers and other gear.
- Individual wide-swing doors with full-length stainless steel piano hinge. Doors measure 18 in. x 21-1/2 in. for easy access.
- One hand operation to open doors. The latch cover prevents access for bears.
- Each compartment door has its own latch and can be padlocked closed (padlock not included).
- Includes support bases (bolt-on) with leveling feet to adjust for an uneven surface. Each adjustable "foot" has a 3/4" x 2" slot to accommodate different surface conditions and positions for anchoring.
 - Locker top, sides, floor and door panels are fabricated using heavy 12 ga. steel plate.
 - The bottom compartment floor is 18" above the ground surface and meets the ADA guidelines for reach and operability.
 - Includes a set of (4) 1/2" x 5" concrete screw anchors (#ANC5-4).
 - Additional 2-compartment lockers can be bolted together side-by-side to create an array of lockers to accommodate your unique requirements. Fasteners included.
 - Textured powder coat paint finish is available in five colors: brown (/CWT), green (/CNT), black (/CBT), blue (/CUT), speckled tan (/CTT). See Page 53.
- **Optional:** "Food Storage" decal #DE-36/2.



Model BPFL-T/CWT-18 lockers can be mounted side-by-side with included fasteners.



Model BPFL-T/CTT-18 Bear Resistant Trail Side Locker with textured speckled tan powder coat finish, two 9 cu. ft. compartments.



Optional Food Storage Locker Decal #DE-36/2 can be used with all BPFL Series lockers. Decal measures approx. 5" x 6". Black on white vinyl

LANTERN POLES. . . *Single, Double, Accessible*



Rules Plate Option:
Use **Model RP/G** for posting park regulations, notices and fees. This 6" x 12" steel plate is fastened to the pole at eye level and provides a flat surface for decals or adhesive signs. Fits any diameter pole. Requires drilling to retrofit in field.

Shelf Option:
Model LHS/G-1 makes the lantern holder even more functional with a 14" x 20" utility shelf, supported by two gussets welded to the adjustable attachment sleeve. Fits any 2-3/8" OD pole.

Shown: **Model LH/G-1/A:** Model LH/G-1 lantern holder with welded on Wheelchair Accessible Option - an additional lantern arm and hook. This lower position accommodates persons in wheelchairs. **This welded on option is available on all new holders.** (Add "/A" to the end of any model number.)

Shown: **Model LH/G-1** with hot dip galvanized finish. **Model LH-1** features a 90-degree bend and hangs one lantern. Hook is 76" high. **Model LH/G-1:** hot dip galvanized finish. **Model LH/CB-1:** black powder coat finish.

Shown: **Model LH/G-180** with hot dip galvanized finish. **Model LH-180** features a 180-degree bend and hangs one lantern. Hook is 76" high. **Model LH/G-180:** hot dip galvanized finish. **Model LH/CB-180:** black powder coat finish.

Shown: **Model LH/CB-2** with black powder coat finish. **Model LH-2** includes a crossbar with arms curved down at 90 degrees to hang two lanterns. Hooks are 77" high. **Model LH/G-2:** hot dip galvanized finish. **Model LH/CB-2:** black powder coat finish.

- Lantern Holders are designed to safely hang camping lanterns. The 2-3/8" OD steel pipe of each Lantern Holder is installed in a concrete footing to provide a strong, vandal resistant support. The lantern hook is fabricated from 1/2" dia. steel bar.
- Lantern Holders feature single piece, welded construction and come standard with a hot dip galvanized finish to minimize maintenance requirements. An optional powder coat finish is available. See Page 52.

BOLT ON WHEELCHAIR ACCESSIBLE ARM/HOOK

- Bolt on this arm to any 2-3/8" OD pole in the field to add a lantern hook at a wheelchair height. Order **Model LHA/G-1**.



TRAFFIC BARRIER

- In upright position use the traffic barrier to block traffic to restricted areas.
- Fold it down to allow traffic through.
- Can be securely locked in either position.
- Features: Heavy gauge steel fabrication, 3-1/2" OD x 1/8" wall steel pipe post; 10" sq. x 3/8" steel base plate with four 25/32" dia. holes, four 1/2" x 3" screw type concrete anchors (reorder # ANC1-4), stainless steel bolt and 3/4" dia. pin, brass padlock, high visibility yellow powder coat paint finish, reflective decals.
- Dimensions: Erect height 42-3/8", folded height 4-3/16".
- **Optional:** Powder coat paint finish in choice of colors. See Page 52.



Model TB/CY-1 Traffic Barrier will help you block motorized traffic to restricted areas. Shown above in lowered position to allow authorized vehicles to pass.

BOLLARD BARRICADE - Control or deter traffic with this imposing bollard post barricade

- 4-1/2" OD x 10 ga. wall steel pipe post stands 41-3/8" tall after installation.
- **Two installation methods:**
 - **Model TB-2** provides standard post to be embedded into concrete footings. Post is open on one end so you can fill it with concrete if desired.
 - **Model TB/P-2** offers optional bolt down surface installation with welded on 3/8" thick x 10" square base plate; 3" dia. hole in this plate allows you to fill post with concrete before installation if desired; includes set of (4) 1/2" x 5" concrete screw anchors (reorder #ANC5-4).
- Yellow powder coat finish is standard. Other colors available. See Page 52. Each post includes a set of reflective decals.



Model TB/CY-2 Embedded Mount Bollard Traffic Barricade



CAR STOPS

- Available in 6 ft. or 8 ft. lengths.
- Made from 100% recycled plastic. Available in 3 colors.
- Maintenance free – withstands traffic, weather and salt.
- Solid color throughout. Won't chip or fade.
- Anchor holes predrilled.
- Dimensions: 6" wide at base; 4" tall.

Model	Length (ft.)	Weight (lbs.)
CSL-6♦	6	36
CSL-8♦	8	48

Color choices for Car Stops and Speed Bumps	Yellow (PY)	Gray (PA)	Blue (PU)
Replace (♦) in model number with letters indicating color choice			

- **Optional:** Model ANC11-3 set of three 3/4" x 17-3/4" steel anchor stakes with head.
- **Optional:** Model ANC12-3 set of three 3/4" x 24" steel anchor stakes with head.

Model	Length (ft.)	Weight (lbs.)
SB-6♦	6	34
SB-8♦	8	46

SPEED BUMPS

- Available in 6 ft. or 8 ft. lengths.
- Made from 100% recycled plastic. Available in 3 colors.
- Maintenance free – withstands traffic, weather and salt.
- Solid color throughout. Won't chip or fade.
- Anchor holes predrilled.
- Dimensions: 10" wide at base; 2" tall at center.

UTILITY TABLE - *ULT Series*



Model ULT/B-2 with 18" x 48" work top, single post, standard embedded installation.

- **Model ULT** Utility Tables are a popular enhancement to picnic and camp sites by providing a work area so the nearby picnic table can be kept clean and used for other activities. The table is 32" high (nom). These are popular Dutch Oven or Grill tables.
- Simple design makes the ULT Table convenient to use, easy to keep clean. Rugged construction includes: 3/16" thick steel plate top, steel tube or channel iron leg posts. Finish: high heat black enamel paint. Some assembly required.
- Formed 1-3/4" flanges on all four sides reinforce the top for strength. The side and back flanges are formed up to define the work area, the front flange is formed down to offer a blunt front edge and the back corners are left open for easier clean up.
- Embedded post installation is standard.
- **Optional:** Bolt down steel base plate installation for existing surface (anchor bolts not included, use one or two #ANC1-4 kit). *See Page 126.*
- These fixed position Utility Tables come in 3 styles:
 - **Model ULT-1:** 18" deep x 30" wide top; single 4" x 6" rectangular steel tube post.
 - **Model ULT-2:** 18" deep x 48" wide top, single 4" x 6" rectangular steel tube post.
 - **Model ULT-3:** 30" deep x 48" wide top, double 6" steel channel posts. Top is reinforced underneath with two 3/16" x 3" x 3" steel angles.



*(Center)
Model ULT/P/B-3
with 30" x 48" work top,
double post, shown with
optional bolt down base
plate installation.*



ULT Series Utility Tables are great locations for Dutch Ovens and portable Charcoal Grills.

(Right and photo at left) Model ULT/P/B-1 with 18" x 30" work top, single post, shown with optional bolt down base plate installation.

UTILITY TABLE WITH SWIVEL TOP

Model ULT-4 utility table offers these features:

- **Swivel:** 360-degree rotation in either direction with theft proof swivel attachment on 3-1/2" OD steel post. You can compensate for changing light or wind conditions.
- **Taller working height:** 40" (nom.) installed (still within ADA guidelines).
- **Table dimensions:** 3/16" thick steel plate x 18" deep x 30" wide, with formed flanges on all sides for strength.
- **Table Features:** The formed-up flanges on 3 sides help contain your food and utensils. The front formed-down flange presents a blunt front working side.
- **Finish:** High heat black enamel paint.
- **Standard:** **Model ULT/B-4** with standard embedded post installation.
- **Optional:** **Model ULT/P/B-4** with optional surface mount bolt down base plate installation (anchor bolts not included – use #ANC1-4 kit). *See Page 126.*



Model ULT/P/B-4
with optional surface
mount bolt down
base plate installation.

FULL SIZE UTILITY TABLE - APTX Series

A full size serving or prep table

- **Model APTX** utility tables available in 6 or 8 ft. lengths, 30" (nom.) table top height. These larger utility tables can provide work or prep area for several people at the same time.
- Uses the APT Series picnic table top frame (see Page 42) double pedestal 3" x 6" (nom.) rectangular steel tube frame posts. Standard embedded installation. Optional bolt down base plate available (anchor bolts not included, see Page 126).
- Frame finishes available: hot dip galvanized or powder coat. See Page 52 for colors.
- Top materials available: lumber, aluminum, 100% recycled plastic, or thermo-plastic coated expanded steel, perforated steel, or formed steel channel. See Pages 52-57 for colors.



Model APTX/P/G-6HU optional bolt down base plate installation, galvanized frames, 6 ft., thermo-plastic coated perforated steel in blue.

UTILITY TABLE - XTX Series

A portable or stationary work table up to 10 ft. long



Model XTX/CW-6UP utility table, brown powder coated frames, 6 ft., untreated pine lumber.

- **Model XTX** Utility Table is a durable and versatile design variation of our XT Series Picnic Tables (see Page 29).
- Features include: 2-3/8" OD x 11 ga. wall welded steel pipe end frames, 1-5/16" OD diagonal braces, hot dip galvanized frame finish is standard, includes galvanized fasteners. Top is 30" high (nom.).

Available Materials. See Pages 52-57	Lengths (feet)
2x10 Untreated or Pressure Treated Pine	6, 8, 10
Aluminum	6, 8, 10
Thermo-plastic coated D-Type Expanded Steel or R-Type Perforated Steel	6, 8, 10
2x10 100% Recycled Plastic	6, 8
Thermo-plastic coated, formed Steel Channel	6, 8

- Wide stance frame with formed and flattened feet provide a stable portable table. The frame feet include 9/16" dia. holes for anchors (not included, see Page 126) for a secure surface bolt down installation.



SQUARE FRAME UTILITY TABLE - T700 Series

- **T700 Series** utility tables offer a clean cut square end frame design with inlaid top and seat planks.
- Surface mount installation only. Anchor bolts not included. See Page 126.
- All steel, welded component construction. End frames are 2" x 2" x 11 ga. square steel tube. Top/seat framework is 1" x 2" x 14 ga. rectangular steel tube, with formed steel channel reinforcements. All open ends are welded closed with steel end caps.
- All steel frame components have a powder coat finish. See Page 52.
- Top/seat inlay materials 2" x 4" (nom.): 100% recycled plastic in choice of colors. All inlaid planks are installed at the factory. See Page 54.
- Assembly of end frames to top component is required.



Model T700/CB-8PA Utility Table, black powder coat frames, 8 ft. long, 2" x 4" 100% recycled plastic planks in gray color.

Model No.	Length	Top/Seat Inlay Material	Frame Finish
T700-6	6' Rectangular	100% Recycled Plastic 2" x 4" (nom.) planks in cedar color (PC) is standard. Other colors available. See Page 54.	Powder coat black finish (CB) is standard. Other colors available. See Page 52.
T700-8	8' Rectangular		
TQ700-4	4' Square		

CONDIMENT SERVING TABLE

- **Model CST** is designed as a concession area table to serve up condiments, utensils and supplies. This allows your concession stand customers to step away from the serving window to prepare their purchase to their own tastes.
- Support posts are 2-3/8" OD steel pipe with a welded on base plate of 1/4 in. x 8 in. steel plate with four 3/4 in. dia. holes.
- **Standard:** Surface mount/bolt down installation (anchor bolts not included).
- **Standard frame finish:** hot dip galvanized after fabrication.
- **Optional frame finish:** powder coating in choice of colors. *See Page 52.*
- Table top is 2-1/2 in. x 12 in. wide (nom.) 12 ga. perforated steel with integrated edge banding and 10 ga. internal mounting angles. Top is thermo-plastic coated in choice of colors. *See Page 57.*
- Height: 46 inches from ground surface to table top.
- Length: 4, 6, 8 or 10 feet long (10 ft. table has three posts).
- **Optional:** Surface mount anchor kit #ANC5-4. Use one kit per post. *See Page 126.*
- **Optional:** Longer posts (no base plate) for embedded installation into concrete footings.



Model CST/P/CB-6HY12 Condiment Serving Table, black powder coated frames with bolt-down base plate option, 6 ft. long, thermo-coated perforated steel top in yellow.

MARKSMAN SHOOTING TABLE - MST-1 Series

- A durable marksman table for outdoor shooting ranges and gun clubs, designed by experienced marksmen.
- Two installation options:

Model MST-1R offers embedded post installation into concrete footings.

Model MST/P-1R includes welded on base plates on each frame leg for a surface mount/bolt down installation. The welded on base plates are 1/4 in. x 8 in. x 8 in. square with (4) 25/32 in. diameter holes. Anchor bolts not included. *See Page 126.* Use (3) #ANC5-4 anchor kits.

- Table top and swivel seat are fabricated using 14 ga. perforated steel with 2-1/2 in. wide edge band with supporting 14 ga. reinforcements. Mounting brackets are formed using 7 ga. steel. Top and seat components are thermo-plastic coated in your color choice. *See Page 57.*
- Top Dimensions: Table top is 34 in. wide by 48 in. deep. Installed height is 55-1/2 in. to top of table (all dimensions nominal).

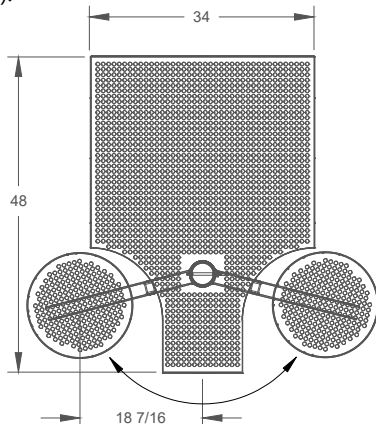

Model MST/P/CB-1RN Marksman Shooting Table, black powder coated frames with optional bolt-down base plate, thermo-coated perforated steel top/seats in green. The swivel seat accommodates both left- and right-handed users.

- **Seat Dimensions:** Swivel seat is 16 in. diameter. Once installed on the support post the swivel seat cannot be removed. The seat offers six 1-inch height adjustment options from 20-1/4 in. to 25-1/4 in. (nom.) using a locking pin.
- The twin radius-cut table top design and the swivel seat are designed to accommodate left-handed and right-handed shooters.
- The top is supported by a tripod using two 2-3/8 in. OD steel pipe posts and one 3-1/2 in. OD post. The swivel seat is installed on the 3-1/2 in. post. The swivel seat arm is a welded assembly of 7 ga. steel and 4-inch OD steel tube.
- **Standard:** Hot dip galvanized finish on frame components after fabrication for maximum protection from the elements.
- **Optional:** Powder coated frame finish in your color choice. *See Page 52.*

PLANTERS - Add some color and flair to your landscape.

- **Model P-10 Series Planters** match our round TRH Series trash and recycling receptacles. See Page 64. Top and bottom steel frame rings can be galvanized or powder coated in your color choice. The slats are 2" x 4" (nom.) available in treated pine or colorful 100% recycled plastic. See Pages 53-54. Assembly is required. Dimensions: 25" tall x 26-1/2" OD (nom.). A heavy duty rigid plastic liner is included. Match with wood and plastic benches on Pages 9-11.
- **Model P-22 Planter** is designed to coordinate with the round CN-R/SS2-36 steel strap trash receptacle. See Page 62. Features include: all steel and all welded fabrication, attractive flare top, and a durable powder coat finish in your color choice. See Page 52. Ships fully assembled. Dimensions: 23" tall x 29" OD (nom.). Includes four leveling feet. A heavy duty rigid plastic liner is included. Match with steel strap benches on Pages 18-19.
- **Model P-23 Planter** is designed to coordinate with the round CN-R/SS3-36 steel strap trash receptacle. See Page 63. Features include: all steel and all welded fabrication, new die formed wavy vertical straps, and a durable thermo plastic coat finish in your color choice. See Page 55. Ships fully assembled. Dimensions: 25-1/2" tall x 29" OD. Includes four leveling feet. A heavy duty rigid plastic liner is included.
- All planters include this 20" tall x 20" (nom.) diameter heavy duty rigid plastic liner, black color only. Order **Model CN/B-3001F** for replacement.



Model P-10/G-TP Planter, galvanized steel frame, treated pine slats.



Model P-10/G-PY Planter, galvanized steel frame, yellow recycled plastic slats.



Model P-22/CU Planter, steel strap design with flared top, powder coated blue.



Model P-23/TN Planter, wave steel strap design, thermo-plastic coated green.

TOILET TISSUE DISPENSERS

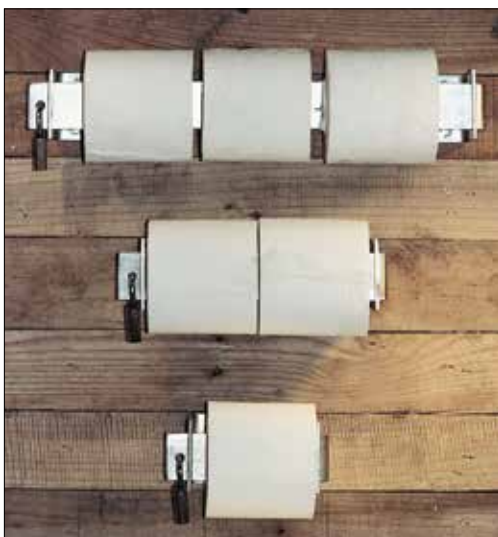

Shown:
Model TH-3: Triple Roll Dispenser
Model TH-2: Double Roll Dispenser
Model TH-1: Single Roll Dispenser with optional Model PL-1 padlock

- **Model TH** Toilet Tissue Dispensers are made with sturdy steel wall brackets and cross bars to stand up to abuse. The optional Model PL-1 brass padlock will prevent theft.
- Toilet Tissue Dispensers are available in 3 models to hold from 1 to 3 rolls. See the chart below. **Models TH-1** and **TH-2** use 3/16" thick steel wall brackets and 3/16" x 2" wide cross bar. **Model TH-3** has 3/16" thick wall brackets that span 16" wall stud centers and a 1/4" thick x 2" wide cross bar. Model TH-3 can serve as a paper towel holder.
- The 2- and 3-roll models can be equipped with a 1-1/2" wide cross bar which will allow the tissue rolls to turn easily. Order **Models TH-2F** or **TH-3F**. See chart below.
- All models have a zinc plated finish. Wall mounting fasteners are not included.

Model No.	Number of Rolls	Cross Bar Dim. (in.)	Feature
TH-1	1	3/16 x 2	Rolls won't turn easily, prevents waste and extreme use.
TH-2	2	3/16 x 2	
TH-3	3, or 1 roll paper towels	1/4 x 2	
TH-2F	2	1/4 x 1-1/2	Rolls turn easily, accommodates elderly or disabled persons
TH-3F	3, or 1 roll paper towels	1/4 x 1-1/2	

Wayfinding and Informational Signs

- Square sign material is .120" thick with laminated white aluminum on both surfaces and a solid black polyethylene core.
- Vinyl is 3M brand high performance vinyl with a 7-year warranty.
- Sign image is on one side only. Sign vinyl is available in 3 colors: brown, green and blue. Sign background colors will be white. Type will be reversed on sign.
- Three sign sizes: 3" or 9" or 12" square.
- Two mounting holes: 3" sign has two 3/16" dia. screw holes; 9" and 12" signs have two 3/8" bolt holes. Fasteners are not included.
- **Optional:** Sign posts and fasteners. *See Page 89.*



	BROWN	GREEN	BLUE	Optional Sign Posts Available
Size	Model Number			
3" Square	SN-M/W3-###	SN-M/N3-###	SN-M/U3-###	SN-PP44 Only
9" Square	SN-M/W9-###	SN-M/N9-###	SN-M/U9-###	SN-PFC-8, SN-PSO-8, SN-PP44, or SN-PP66
12" Square	SN-M/W12-###	SN-M/N12-###	SN-M/U12-###	
<i>Replace "###" in part number with Symbol number of choice.</i>				

MEN'S ROOM #101	WOMEN'S ROOM #102	REST ROOMS #103	SHOWERS #104	LAUNDRY #105	LOCKER #106	PHONE #107	HOSPITAL #108	FIRST AID 1 #109	FIRST AID 2 #110
ALCOHOL #111	FOOD #112	GROCERIES #113	LODGING #114	AMPHITHEATER #115	WHEELCHAIR ACCESS #116	CHANGING STATION #117	DRINKING FOUNTAIN #118	FIRE EXTINGUISHER #119	MAILBOX #120
RECYCLE #121	WI-FI HOT SPOT 1 #122	WI-FI HOT SPOT 2 #123	WI-FI HOT SPOT 3 #124	POISON #125	ATM #126	SMOKING #127	LITTER CONTAINER #128	ARCHAEOLOGICAL SITE #129	BEAR-VIEWING AREA #130
DEER-VIEWING AREA #131	WATCHABLE WILDLIFE #132	FISH #133	INFORMATION #134	SCENIC AREA #135	TRAIL SHELTER #201	SLEEPING SHELTER #202	LOCAL FIREWOOD #203	TENT AREA #204	PICNIC SHELTER #205
CAMPER PARKING #206	RV SANITARY STATION #207	PICNIC TABLE #208	ELECTRICAL HOOKUP #209	CAMPING #210	TENT CAMPING #211	PICNIC AREA #212	DRINKING WATER #213	LOOKOUT TOWER #214	NATURE STUDY #215
TRAIL INFO #216	FIREARMS #217	WEAPONS #218	RANGER STATION #219	CAMP FIRE #220	KENNEL #221	LEASHED PETS #222	DOGS / PETS #223	DIAGONAL ARROW RIGHT #301	DIAGONAL ARROW LEFT #302
DIRECTIONAL ARROW #303	LEFT OR RIGHT ARROW #304	UP OR DOWN ARROW #305	WARNING CAUTION #306	TRUCKS #307	AUTOMOBILES #308	PEDESTRIAN CROSSING #309	TUNNEL #310	BUS STOP #311	PARKING #312

SIGNS

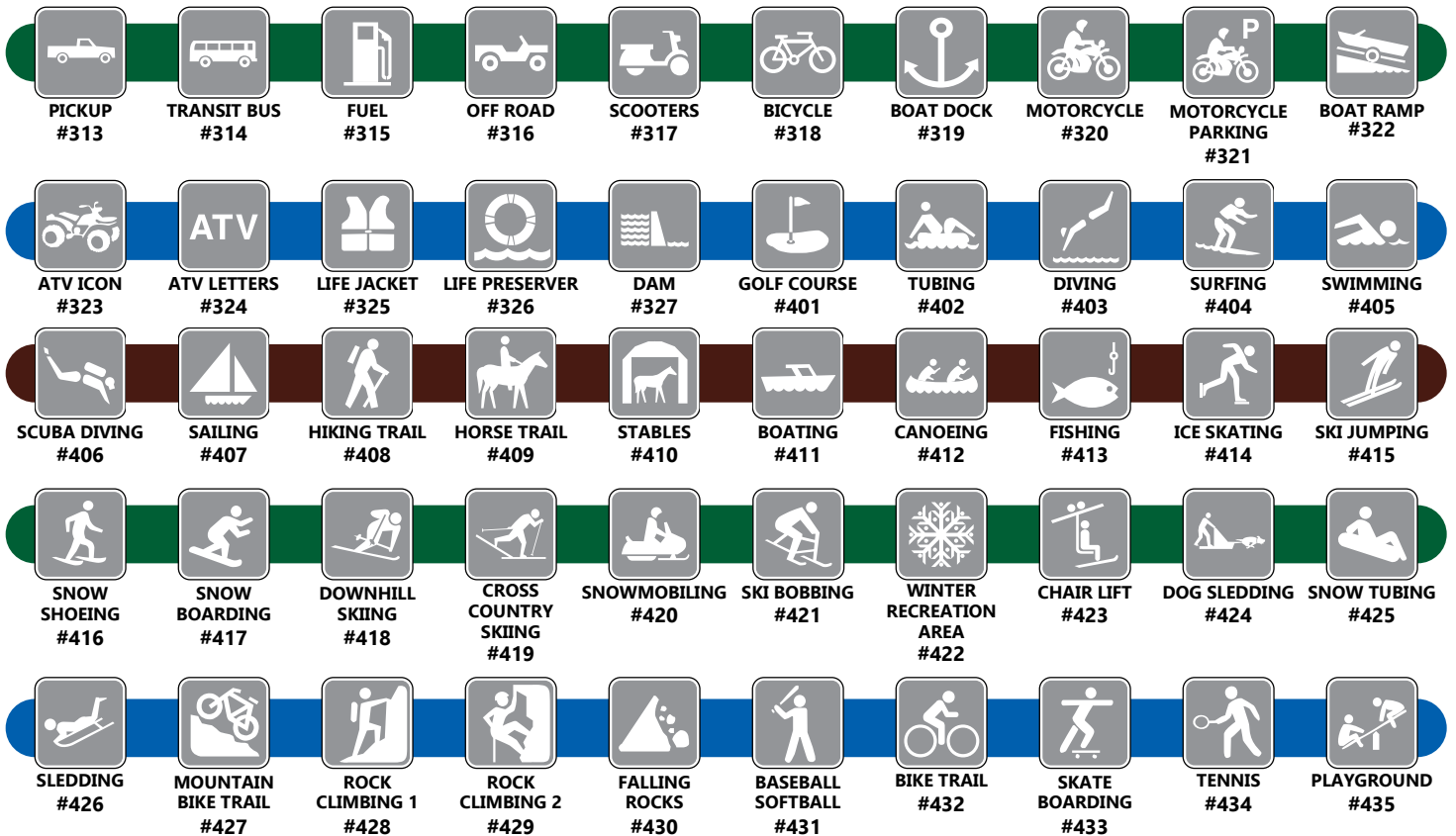

Add the "NO" icon to any sign to show activities and services that are not available.



Examples Shown:

12" - brown - #219 Ranger Station

9" - green - #205 Picnic Shelter

3" - blue - #116 Wheelchair Access

**Don't see the sign you need?
Contact us!**

Need A Post For Your Sign?

We offer four types of posts for your marker signs – 4" x 4" or 6" x 6" square 100% recycled plastic posts, fiberglass or steel posts. Refer to this chart for post details and sign sizes.

MODEL	DESCRIPTION	WT. (lbs.)	Signs Available
SN-PP44	Recycled plastic 4" x 4" (nom.) square, can be 5, 6, or 8 ft. long. Specify length and color (<i>see Page 54</i>).	22 (5') 27 (6') 36 (8')	3, 9, and 12 in. square signs
SN-PP66	Recycled plastic 6" x 6" (nom.) square, 8 ft. long. Specify color (<i>see Page 54</i>).	78	9 and 12 in. square signs only
SN-PFC/N-8	Fiberglass, closed channel, green color, 8 ft.	6	
SN-PSO/N-8	Steel, open channel, green baked on enamel, 8 ft.	16	
#900-077	Fastener Package for Steel and Fiberglass Post, set of (8) 5/16" x 2-1/2" zinc plated slotted machine screw with nut.	1	



(Left) Model SN-PFC/N-8 fiberglass closed channel post.

(Right) Model SN-PSO/N-8 steel open channel post.

SAFETY BICYCLE RACK

- The Safety Bicycle Rack is designed with gently curved arches. The base angles face down to eliminate any vertical edges.
- With a 2-1/4" inside stall width this rack will accommodate bikes in a wide variety of sizes. Models are available in single-side (to fit adjacent to walls) and double-side styles (to hold bikes on both sides). Both styles can be ganged together on the ends to supply the needed amount of parking. Bikes are parked on 16" centers per side.
- Construction: welded, fully assembled hoops of 1/2" diameter steel bar, 1/8" x 1-1/4" x 1-1/4" formed steel base angles, and hot dip galvanized finish for maximum protection from weather and bikes. Zinc plated fasteners included.
- All assembly fasteners are pointed towards the ground with nuts concealed from view inside base angle to deter theft. Shipped unassembled.
- **Optional:** Model BR-4HSA set of (4) 3/8" x 1-7/8" hex sleeve anchors to secure bike rack to concrete surface.



Model BR-12DS 95 in. long, double side parking to hold up to 12 bikes.



Model BR-6SS 95 in. long, single side parking to hold up to 6 bikes.

MODEL NO.	NO. OF BIKES	SIDES OPEN	L X W X H (INCHES)	ANCHORS
BR-6DS	6	DOUBLE	48 x 20-1/4 x 12	BR-4HSA See Page 126.
BR-6SS	6	SINGLE	95 x 20-1/4 x 12	
BR-12DS	12	DOUBLE	95 x 20-1/4 x 12	

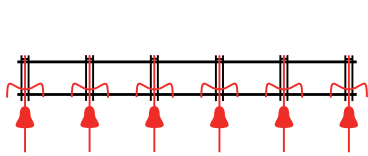

Single Sided Bike Rack

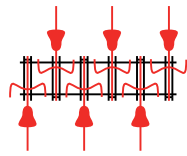

Double Sided Bike Rack

OMEGA BIKE RACK

- The Omega Bike Rack provides secure parking with classical styling.
- Each Omega Rack will hold up to 2 bikes of any size and style. All popular types of locking devices may be used.
- Available with hot dip galvanized finish for maximum protection, or with a powder coat finish in your choice of colors. See Page 52.
- The Omega can be installed individually or in groups. It lends itself to many creative landscape patterns.
- Dimensions: 32" tall at center, 36-3/4" wide at center. Fabricated using 1.90" steel pipe.
- Surface mount installation (anchor bolts, not included).
- **Optional:** Model ANC3-6 set of (6) 3/8" dia. x 3" heavy duty screw anchors for concrete surface.

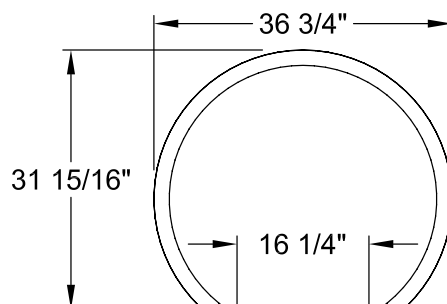

Model ORP/CR bike rack, red powder coat finish.

BOLLARD BIKE RACK

- Single post "bollard" type bike rack, with parking for 2, 4, or 6 bikes of any style. Will work with most bike locking devices.
- Dimensions: 35" tall, 28-1/4" wide (with two loops), 28-1/4" square (with four or six loops).
- Powder coat finish available in choice of colors. *See Page 52.*
- Durable steel fabrication: 4-1/2" OD x 10 ga. wall central post, 1-1/2" OD steel tube bike loops, 1/4" x 8" base plate, all welded fabrication.
- Surface mount installation, (requires four 1/2" dia. anchor bolts, not included).
- **Optional:** Model ANC1-4 set of (4) 1/2" dia. x 3" heavy duty screw anchors for concrete surface. *See Page 126.*



(Above) **Model BR104/CB** bollard bike rack will park 4 bikes. Black powder coat finish.



Model BR102/CU bollard bike rack will park 2 bikes. Blue powder coat finish.



(Left) **Model BR106/CR** bike rack holds 6 bikes. Red powder coat finish.



Shop Online at pilotrock.com

Join our e-newsletter for the latest information and promotions ...
go to pilotrock.com



Model BR20/TU Hoop Rack, blue thermo-plastic coat finish.

HOOP BIKE RACK

- **Model BR20** Hoop Bike Rack provides secure parking for two bikes of any size and style. All popular locking devices may be used.
- The Hoop Rack can be installed singly or in groups. Surface mount installation only (anchor bolts not included).
- Finished with thermo-plastic coating in your choice of colors. *See Page 55.*
- **Dimensions:** 29" diameter x 34" tall. Fabricated using 1/4" thick x 2-1/2" steel plate, with a 1/4" x 8" sq. steel base plate.
- **Optional:** Model ANC1-4 set of (4) 1/2" dia. x 3" heavy duty screw anchors for concrete surface. *See Page 126.*

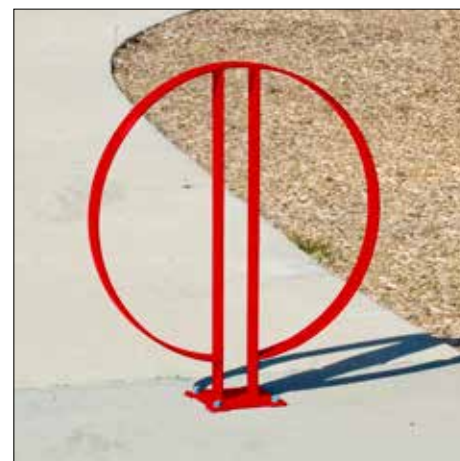

Model BR20/TR Hoop Rack, red thermo-plastic coat finish.



Model BR205SS/G single sided hot dip galvanized bike rack with "D" style end frames. Holds five bicycles.



Model BR210DS/G double sided hot dip galvanized bike rack with "Bell" style end frames. Holds ten bicycles.



Model BR220DS/CN double sided bike rack with "Bell" style end frames. Green powder coat finish. Showing extension which doubles the parking capacity. Holds twenty bikes.

VERTICAL BIKE RACK

- Tall vertical stalls hold the front or back bike tire secure.
- The end frames and cross tube structures are fabricated using 1.66" OD x 10 ga. wall steel tube; the vertical stall bars are 5/8" OD steel bar (not hollow tube). All welded component fabrication. Stall structure bolts to end frames so racks ship flat to reduce freight and handling costs.
- Using the same stall structure, with interchangeable end frames, a variety of bike racks can be built – offering you choices of design and parking capacity.
- Single-sided racks will hold from 5 to 10 bikes. Double-sided racks will park from 10 to 20 bikes. See chart below.
- Double the parking capacity of a basic bike rack by adding an identical set of stalls. A matching center frame joins the stall sections together.
- Choose a finish. All rack designs are available with a powder coated paint finish in your choice of colors. See Page 52. A hot dip galvanized finish is also available. See chart below.
- These versatile bike racks will hold all types of bikes and most locking devices can be used.
- **Optional:** Order a set of 4 or 6 heavy-duty screw anchors to secure your bike rack to a concrete surface. See chart below.
- **Optional:** Custom end panels with laser cut signage can provide identity for your agency, school or business.



Ask about custom signage for your BR210 or BR220 bike rack.

End Frame Style	Model No.	No. of Bikes	Sides Open	Available Finish*		Profile & No. of Sections	L x W x H (in inches)	Optional H.D. Anchor Kit for Concrete
				Hot Dip Galv.	Powder Coat			
"D"	BR205SS/◆	5	Single Side	Yes (/G)	Yes	(1)	76 x 23 x 33	#ANC2-4 (4) 3/8" x 5"
	BR210SS/◆	10	Single Side	Yes (/G)	Available with powder coat finish. See Page 52 for color choices	(2)	150 x 23 x 33	#ANC2-4 (4) 3/8" x 5"
"Bell"	BR210DS/◆	10	Double Side	Yes (/G)		(1)	76 x 46 x 33	#ANC2-4 (4) 3/8" x 5"
	BR220DS/◆	20	Double Side	Yes (/G)		(2)	150 x 46 x 33	#ANC2-6 (6) 3/8" x 5"

*Replace (◆) in Model number with finish designation, e.g. BR205SS/G. See Page 52 for powder coat colors.

“WHEEL” STYLE VERTICAL BIKE RACK

- Tall vertical stalls hold the front or back bike tire secure.
- The end frames and cross tube structures are fabricated using 1.66" OD x 10 ga. wall steel tube; the vertical stall bars are 5/8" OD steel bar (not hollow tube). All welded component fabrication. Stall structure bolts to end frames so racks ship flat to reduce freight and handling costs.
- Double-sided racks will park from 10 to 20 bikes. See chart below.
- Double the parking capacity of a basic bike rack by adding an identical set of stalls. A matching center frame joins the stall sections together.
- Powder coat finish available in choice of colors. See Page 52.
- These versatile bike racks will hold all types of bikes and most locking devices can be used.
- **Optional:** Order a set of 4 or 6 heavy-duty screw anchors to secure your bike rack to a concrete surface. See chart below.



Model BR310DS/CU
double sided bike rack with "Wheel" style end frames.
Blue powder coat finish. Holds ten bicycles.

End Frame Style	Model No.	No. of Bikes	Sides Open	Available Finish	Profile & No. of Sections	L x W x H (in inches)	Optional H.D. Anchor Kit for Concrete
 "Wheel"	BR310DS/◆	10	Double Side	Powder Coat is standard See Page 52 for color choices	(1)	80 x 33 x 33	#ANC3-4 (4) 3/8" x 3"
	BR320DS/◆	20	Double Side		(2)	153 x 33 x 33	#ANC3-6 (6) 3/8" x 3"

*Replace (◆) in Model number with color designation, e.g. BR310DS/CU. See Page 52 for powder coat colors.

STEEL WHEELS BIKE RACK

- The bicycle shape is something everyone will recognize for bike parking. Each rack can support the bicycle in two places. Most types of locking devices may be used.
- Both bike racks use 1.66 inch OD x 10 ga. wall steel tube for the bike shapes. Fully welded assembly.
- Powder coat finish available in choice of colors. See Page 52.
- Surface mount installation only, with 3/16-inch thick steel angles welded to each wheel, providing 8 anchor points per rack for a stable and secure location.
- **Optional:** Order (2) #ANC1-4 sets of (4) 1/2-inch x 3-inch concrete screw anchors. See Page 126.



Model BR30/CN bike rack with Green powder coat finish.



(left) **Model BR30/CE** bike rack with burgundy powder coat finish.

	Model No.	Number of Bikes	Finish	Dimensions H x W	Installation	Optional Anchor Kit
	BR30/◆	2	Powder Coated See Page 52	41" x 50"	Surface Mount. (8) anchors required per rack (not included). 9/16" dia. mounting holes	Order (2) #ANC1-4 sets of (4) 1/2" x 3" concrete screw anchors See Page 126
	BR31/◆	2-4		45" x 76"		

Replace (◆) in Model Number with Powder Coat Finish color choice initials. See Page 52.

HITCHING POST BIKE RACK



Model HRE/G bike rack, embedded post installation.

- The Hitching Post Bike Rack is constructed from heavy 2-3/8" OD steel pipe and features a hot dip galvanized finish for maximum protection from weather and bikes.
- Each single Hitching Post will hold up to 2 bicycles of any style. Bikes can be secured at the front wheel, back wheel or frame. Most types of securing devices may be used.
- Two installation methods are available (see below). **Model HRE** has a longer leg for embedment into concrete footings. **Model HRP** is surface mounted with bolt down base plates (3/8" dia. anchor bolts not included).
- 2-part aluminum cover caps are included. See chart below.
- **Optional:** Powder coat finish. See Page 52.
- **Optional:** Thermo-plastic coat finish. See Page 55. Not available with sign plate using a vinyl decal.
- **Optional:** Model ANC3-4 set of (4) 3/8" dia. x 3" heavy duty screw anchors for concrete surface. See Page 126.
- **Optional:** Welded in steel plate for your custom signage (add "S" to model number). Custom signage can be laser cut design or a full-color vinyl decal.

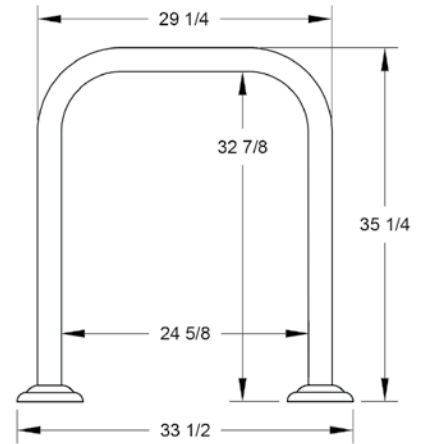

Model HRPS/CN bike rack with optional signage plate and custom laser cut image, powder coated green.

Two Installation Choices



Model HRE racks have extended legs for embedding into concrete footings.

Optional: 2-part aluminum cover caps are available for each leg. Add /C to model number.

Model HRP racks are surface mounted by means of a bolt down base plate for use with two 3/8" anchor bolts (bolts not included). 2-part aluminum, cover caps are included.

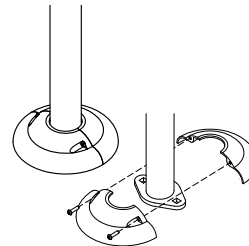

COVER CAPS WILL MATCH BIKE RACK COLOR.

NOTE: Cover caps are not available when HRE/HRP bike racks are thermo-plastic coated.

HITCHING POST GROUP RACK



Model HRP/CY-8 Group Rack, powder coated yellow, holds eight bikes.

- Group the single hitching post racks together to create parking for 6 to 8 bikes.
- Features: Welded on base plates bolt to base channel, carriage bolt fasteners with nut under channel for a secure assembly, formed steel base channel is 1" x 4" (nom.) x 10 ga., holes in base channel for surface anchors, hot dip galvanized finish on all components is standard.
- Two sizes:
 - Model HRP-6** will park up to 6 bikes (66 in. long).
 - Model HRP-8** will park up to 8 bikes (96 in. long).
- **Optional:** Powder coat finish. See Page 52.
- **Optional:** Concrete screw anchors. See Page 126.

	MODEL NO.	NO. OF BIKES	INSTALL METHOD	WIDTH (IN.)	LENGTH (IN.)	OPTIONAL ANCHOR KIT
	HRP-6	6	Surface Mount	31-1/4	66	ANC2-4 (4) 3/8" X 5"
	HRP-8	8	Surface Mount		96	ANC2-6 (6) 3/8" X 5"



Model SRE/G-7 bike rack, embedded installation, will park up to 7 bikes.

SADDLEBACK BIKE RACK

- The Saddleback Bike Rack incorporates a graceful, continuous loop design. It will accommodate all types of bikes and all popular locking devices.
- The Saddleback Rack is formed using heavy gauge 2-3/8" OD Schl. 40 steel pipe, and offers a hot dip galvanized finish for maximum protection from weather and bikes.
- This rack can mount a bicycle at each end, plus a bike in each ascending or descending loop. Models are available to park from 3 to 13 bikes. **Model SRE** has a longer leg for embedment into concrete footings. **Model SRP** is surface mounted with bolt down base plates (3/8" dia. anchor bolts not included).

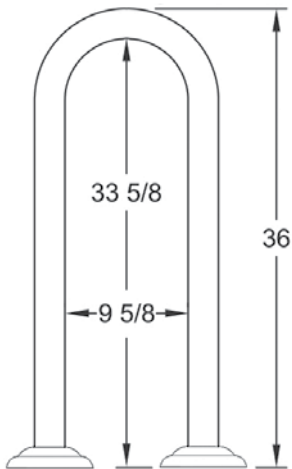

- 2-part aluminum cover caps are included with SRP racks. See chart below.
- **Optional:** Powder coat finish. See Page 52.
- **Optional:** Model ANC3-4 set of (4) 3/8" dia. x 3" heavy duty screw anchors for concrete surface. Model SRP/G-13 requires anchor kit ANC3-6. See Page 126.



Model SRP/G-5 bike rack, surface mount installation with base plate, includes cover caps, will park up to 5 bikes.

	1 2 3	1 2 3 4 5	1 2 3 4 5 6 7	1 2 3 4 5 6 7 8 9	1 2 3 4 5 6 7 8 9 10 11	1 2 3 4 5 6 7 8 9 10 11 12 13
# of Bikes	3	5	7	9	11	13
Length (nom.)	14"	38"	62"	86"	110"	134"
Embedded Models	SRE/G-3	SRE/G-5	SRE/G-7	SRE/G-9	SRE/G-11	SRE/G-13
Base Plate Models	SRP/G-3	SRP/G-5	SRP/G-7	SRP/G-9	SRP/G-11	SRP/G-13

*Note: Saddleback Bicycle Racks feature a nominal 12" center to center between loops. Listed lengths are nominal and may vary due to bending tolerances.

Model SRE racks have extended legs for embedding into concrete footings.

Optional: 2-part aluminum cover caps are available for each leg. Add /C to model number.

Two Installation Choices

Model SRP racks are surface mounted by means of a bolt down base plate for use with two 3/8" anchor bolts (bolts not included). 2-part aluminum cover caps are included.

NOTE: COVER CAPS CAN BE POWDER COATED TO MATCH BIKE RACK FINISH.

ACCESSIBLE GRILL - ASW Series

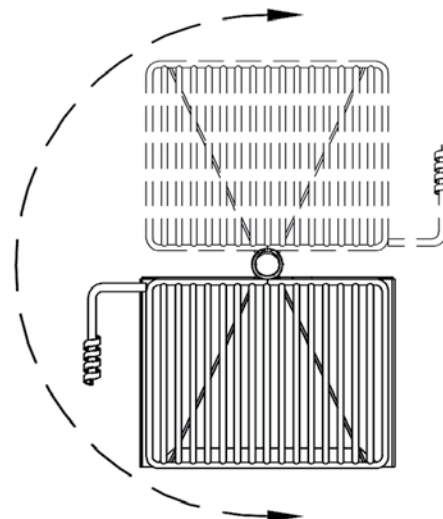

Grate rotates 180° from over the fire with just 5 lbs. of force. The handle is NEVER over the fire.

Model ASW-20 B2 Accessible Grill with single level swivel grate, meets the ADA guidelines for access, reach, and operability. Shown with optional Model S6 Swivel Shelf.

• Two Sizes:

Model ASW-20 offers 300 sq. in. of cooking area

Model ASW-24 offers 360 sq. in. of cooking area

- The single level cooking grate swivels 180 degrees – over the charcoals or completely out of the firebox – but the grate handle is never over the heat.
- The cooking grate requires less than 5 lbs. of force to move, requires only one hand to operate, is less than 34" high.
- The firebox rotates 360 degrees in either direction on theft proof swivel attachment on both models. Standard 3-1/2" OD x 40" long base post for embedded installation (B2).
- The firebox is 6" high on the swivel side, and 10" high on the other side to provide wind protection above the grate.
- All welded firebox construction: 3/16" (7 ga.) thick steel, plus die-formed flange to retain ashes and reinforce the firebox from heat.
- **Model ASW-24** features ring reinforcement under the firebox to dissipate heat and prevent warpage.
- All welded cooking grate fabrication: 1/2" diameter solid steel bars, mounted on steel tube allowing it to swivel 180 degrees. The operator handle includes a 1/8" x 1/2" flat bar coiled grip. All grate bars are welded on both sides.
- Finished with high temp, non-toxic black enamel paint.
- **Optional:** Model B18 surface mount base post (instead of standard embedded post). Surface anchor bolts are not included. Becomes Model ASW-20 B18.
- **Optional:** Swivel shelf Model S6 installs on 3-1/2" OD base post.

Accessible Grill in Stainless Steel

• Two Sizes:

Model ASWS-20 offers 300 sq. in. of cooking area

Model ASWS-24 offers 360 sq. in. of cooking area

- **Model ASWS-20 and ASWS-24** grills have fireboxes fabricated from 304 grade stainless steel for the back 7 ga. (3/16") and the sides/bottom 11 ga. (1/8"). Both fireboxes include integral die-formed flanges to retain ashes and to reinforce the firebox from heat warpage, including stainless steel reinforcement braces under the firebox. Stainless steel wire welded.
- 2-3/8" OD stainless steel pipe base post (B6S) for embedded installation.
- Stainless steel cooking grate is laser cut from 7 ga. (3/16") thick stainless steel plate, stainless swivel tube and handle.
- Stainless steel components are not painted. There will be visible weld marks.
- **Optional:** stainless steel surface mount base post Model B19S (to replace standard embedded post), 2-3/8" OD with welded on 8" square base plate. Grill becomes Model ASWS-20 B19S. Anchor bolts are not included (use #ANC1-4SS).

Model B2
Embedded Base
(black enamel)



Model B6S
Embedded Base
(stainless steel)

Model B18
Surface Mount Base
for ASW-20 & ASW-24
(black enamel)



This charcoal grill has been designed to meet the rules presented in the Draft Final Accessibility Guidelines for Outdoor Developed Areas 1011.3 (ADA-ABA 309.4) and 1011.5 (ADA-ABA 902.3) as presented by the U.S. Access Board Oct. 19, 2009.

CHARCOAL GRILLS



Model ASW-20 B2

Firebox Dimensions (D x W x H) 15" x 20" x 6"-10"
 Cooking Area (Sq. In.) 300
 Finish High-Temp Enamel
 Vertical Grate Adjustment None
 Horizontal Grate Adjustment 180°
 Weight 76 lbs.
 Optional Shelf S6
 Base Options B2 (Standard), B18
 Grate Option None



Model ASWS-20 B6S

Firebox Dimensions (D x W x H) 15" x 20" x 6"-10"
 Cooking Area (Sq. In.) 300
 Finish (Firebox & Post) Stainless Steel
 Vertical Grate Adjustment None
 Horizontal Grate Adjustment 180°
 Weight 60 lbs.
 Optional Shelf None
 Base Options B6S (Standard), B19S
 Grate Option None



Model ASW-24 B2

Firebox Dimensions (D x W x H) 15" x 24" x 6"-10"
 Cooking Area (Sq. In.) 360
 Finish High-Temp Enamel
 Vertical Grate Adjustment None
 Horizontal Grate Adjustment 180°
 Weight 86 lbs.
 Optional Shelf S6
 Base Options B2 (Standard), B18
 Grate Option None



Model ASWS-24 B6S

Firebox Dimensions (D x W x H) 15" x 24" x 6"-10"
 Cooking Area (Sq. In.) 360
 Finish (Firebox & Post) Stainless Steel
 Vertical Grate Adjustment None
 Horizontal Grate Adjustment 180°
 Weight 70 lbs.
 Optional Shelf None
 Base Options B6S (Standard), B19S
 Grate Option None



Model S6 Swivel Shelf
(for B2 & B18 posts only)



Model B19S
Surface Mount Base
for ASWS-20 & ASWS-24
(stainless steel)



Model GGS/B-1
Grill & Grate Scraper.

Model HCB-1
Hot Coal Bin



PREMIER SERIES GRILL - A, B, C, D Series



(Above) **Model A-20 B2** Premier Park Grill with Infinitely Adjustable cooking grate.

(Right) **Model C2-36/SS B2** Premier Park Grill with two Infinitely Adjustable cooking grates, shown with optional bolt-on utility shelves.

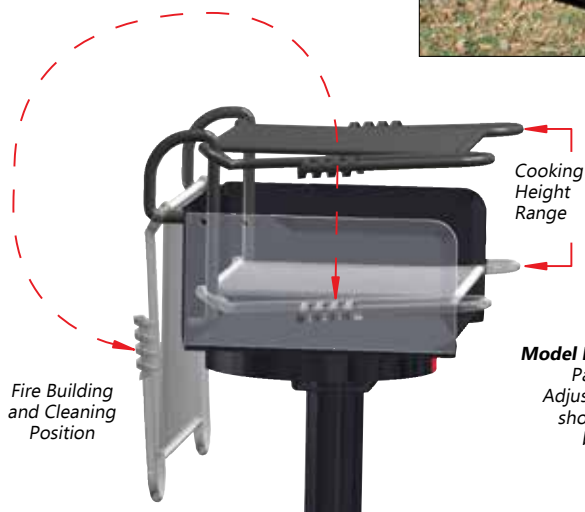

(Right) **Model D2-48/SS B2** Premier Park Grill with Infinitely Adjustable cooking grates, shown with two optional bolt on utility shelves.

(Illustration) Pilot Rock Premier Park Grills feature the original Infinitely Adjustable cooking grate. Grate can be adjusted from just above the coals to as much as 12" above bottom of firebox. Grate lifts over and out of firebox but remains permanently attached.

- The original Infinitely Adjustable cooking grate design, adjusts the cooking surface anywhere from just above the coals to 12 inches above bottom of firebox.
- Cooking Grate tips back out of firebox yet remains attached, for easier fire building and clean out.
- Structurally reinforced cooking grate is virtually indestructible.
- Double Reinforced Firebox: First the bottom is ring reinforced to dissipate heat and prevent warpage. Second, integral formed flanges in front, sides and back panels provide increased field strength. The larger Models C2-36 and D2-48 include additional reinforcing ribs.
- Full 360-degree rotation in either direction, on theft-proof swivel attachment. Standard 3-1/2" OD x 40" long base post for embedded installation (B2 in model number).
- Coiled handle grips are fabricated from 1/8" x 1/2" steel bar (not wire springs).
- All-welded firebox and grate construction. No rivets or bolts. Firebox is fabricated from 3/16" thick (7 ga.) steel. Grate is constructed using 5/8" dia. perimeter and handlebars and 1/2" dia. center bars. Model D2-48 uses 3/4" dia. handlebars. All grate bars are welded on both sides.
- Entire unit is finished with high temp non-toxic black enamel paint.
- **Optional:** Surface mount, portable or caster bases; Bolt on utility shelves; swivel shelf. See illustrations below.



Model B2
Embedded Base
(Standard on all models)



Model B3 Surface
Mount Base



Model B14 Caster
Base



Model B4
Portable Disk
Base

CHARCOAL GRILLS



Model A-20/S B2
with optional shelf

Firebox Dimensions (D x W x H)..... 16" x 20" x 8"
 Cooking Area (Sq. In.)..... 320
 Vertical Grate Adjustment
 from Bottom of Firebox 3-3/4"-12"
 Weight..... .83 lbs.
 Optional Shelf (1) S1, (1) S6
 Base Options B2 (Standard), B3, B4



Model B-24/S B2
with optional shelf

Firebox Dimensions (D x W x H)..... 16" x 24" x 8"
 Cooking Area (Sq. In.)..... 384
 Vertical Grate Adjustment
 from Bottom of Firebox 3-3/4"-12"
 Weight..... .91 lbs.
 Optional Shelf (1) S1, (1) S6
 Base Options B2 (Standard), B3, B4

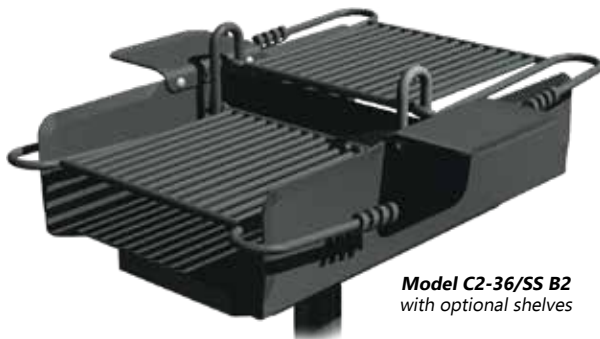

Model C2-36/SS B2
with optional shelves

Firebox Dimensions (D x W x H)..... (2) 16" x 20" x 8"
 Cooking Area (Sq. In.)..... 640
 No. of Grates 2
 Vertical Grate Adjustment
 from Bottom of Firebox 3-3/4"-10-1/2"
 Weight..... .145 lbs.
 Optional Shelf (1 or 2) S1
 Base Options B2 (Standard), B3, B4, B14



Model D2-48/S B2
with optional shelf

Firebox Dimensions (D x W x H)..... .32" x 32-1/2" x 8"
 Cooking Area (Sq. In.)..... 1040
 No. of Grates 2
 Vertical Grate Adjustment
 from Bottom of Firebox 3-3/4"-12"
 Weight..... .214 lbs.
 Optional Shelf (1 or 2) S2
 Base Options B2 (Standard), B3, B4, B14



Model S6
Swivel Shelf



Model S1
7-1/8" x 9-5/8"
Shelf



Model S2
9" x 20" Shelf

MULTILEVEL GRILL - N Series



Model N-20/S B2 multilevel grill with optional **Model S3** utility shelf.

Model N-20 B2 multilevel grill, with optional **Model GC/B-1** grill cover, and optional **Model S6** swivel utility shelf.



Model NS/S-20/S B6S multilevel grill with stainless steel firebox and post. Shown with optional stainless steel cooking grate and **Model S3S** stainless steel bolt-on shelf.

- Two sizes: **Model N-20** provides 300 sq. in., and **Model N-24** provides 432 sq. in. of cooking area on the four level adjustable cooking grate.
- **Model N-20** is available with the standard high-temp black enamel finish; or with a hot dip galvanized firebox and post; or with a stainless steel firebox and post.
- **Model N-24** is available with the high-temp black enamel finish or with galvanized firebox and post.
- Stainless steel grill **Model NS-20 B6S** is designed for areas where the natural environment is especially corrosive to (carbon) steel. The stainless steel can retard the onset of "rust out" so the grill remains functional longer, reducing maintenance and replacement costs.
- Full 360° rotation in either direction on theft-proof swivel attachment. Embedded installation of post is standard. Models N-20 and N-24 use a 3-1/2" OD x 40" post. Model NS-20 is mounted on a 2-3/8" OD x 40" long stainless steel post.
- All-welded firebox construction. The N-20 and N-24 firebox is fabricated from 3/16" (7 ga.) thick steel. Model NS-20 grill uses 304 grade 3/16" stainless steel for the bottom and 1/8" thick 304 stainless steel for the sides of the firebox. All designs include integral die-formed flanges to retain ashes and to reinforce the firebox from heat warpage.
- All welded cooking grate construction: fabricated using 5/8" dia. steel bars for support handles, and 1/2" dia. steel bars for the cooking surface; permanently incorporated into the firebox and cannot be removed; finished with high temp non-toxic black enamel paint; handle grips are 1/8" x 1/2" coiled steel bar. All grate bars are welded on both sides.
- **Optional:** Series S3 bolt on utility shelf for all N Series grills.
- **Optional:** Model N-20 and N-24 can be hot dip galvanized to include the firebox and post (example: Model N/G-20 B2G).
- **Optional:** Model N-20 painted grill, N/G-20 galvanized grill, and NS-20 stainless steel grill can be equipped with a stainless steel cooking grate (example: **N/S-20, N/G/S-20, NS/S-20**).
- **Optional:** Model N-20 grill can be built to incorporate a hot plate measuring 8" x 15". This replaces the grate bars in that portion of the total grate (becomes Model N-20/HP).
- **Optional:** Hinged steel grill cover on Model N-20 and N-24 (painted or galvanized finish). The galvanized cover can be used on the NS-20 stainless steel grill. Model S3 shelf cannot be used with cover.
- **Optional:** All standard B2 base posts can be replaced with a portable disk base (B4) or a bolt down base plate (B3).
- **Optional:** Swivel shelf Model S6 installs on 3-1/2" OD base post on models N-20, N/G-20, N-24, and N/G-24. This shelf can be used with the grill cover. Available with painted finish only. See Page 108.



Model B2
(Standard)
Embedded Base
Model B6S for
NS-20 Stainless
Steel Grill



Model B3 Surface
Mount Base
Model B3G Surface
Mount Base (galvanized)
Model B17S Surface
Mount Base Post for
NS-20 Grill

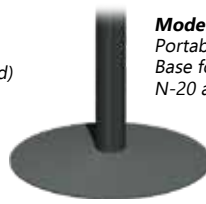

Model B4
Portable Disk
Base for Model
N-20 and N-24



Model GC/B Grill Cover for
Model N-20 or N-24

CHARCOAL GRILLS



Model N-20 B2

Firebox Dimensions (D x W x H)..... 15" x 20" x 10"
 Cooking Area (Sq. In.)..... 300
 Finish.....High-temp Enamel
 Grate Options (N/S) Stainless Steel, or (/HP) Hot Plate
 Vertical Grate Adjustment from Bottom
 of Firebox 3-1/2", 5-1/4", 7", and 8-3/4"
 Weight.....80 lbs.
 Optional Shelf (1) S3, (1) S6
 Optional Grill Cover (S3 Shelf can not be used) (1) GC/B-1
 or Galvanized Grill Cover.....(1) GC/G-1
 Base OptionsB2 (Standard), B3, B4



Model N/G-20/SG B2G
with optional shelf

Firebox Dimensions (D x W x H)..... 15" x 20" x 10"
 Cooking Area (Sq. In.)..... 300
 Finish (Firebox and B2 Post) Hot Dip Galvanized
 Grate Options (N/G/S) Stainless Steel, or (/HP) Hot Plate
 Vertical Grate Adjustment from Bottom
 of Firebox..... 3-1/2", 5-1/4", 7", and 8-3/4"
 Weight.....81 lbs.
 Optional Shelf(1) S3/G (Hot-dip Galvanized), (1) S6
 Optional Galvanized Grill Cover.....(1) GC/G-1
 Base OptionsB2G (Standard), B3, B4, B3G



Model NS-20/S B6S
with optional shelf

Firebox Dimensions (D x W x H)..... 15" x 20" x 10"
 Cooking Area (Sq. In.)..... 300
 Finish.....(Firebox and Post) Stainless Steel
 Grate Options(NS/S) Stainless Steel
 Vertical Grate Adjustment from Bottom
 of Firebox..... 3-1/2", 5-1/4", 7", and 8-3/4"
 Weight.....63 lbs.
 Optional ShelfS3S (Stainless Steel)
 Optional Galvanized Grill Cover.....(1) GC/G-1
 Base OptionsB6S (Standard), B17S



Model N-24 B2

Firebox Dimensions (D x W x H)..... 18" x 24" x 10"
 Cooking Area (Sq. In.)..... 432
 Finish.....High-temp Enamel
 Optional Finish (Firebox and B2 Post) Hot Dip Galvanized
 Grate OptionsNone
 Vertical Grate Adjustment from Bottom
 of Firebox..... 3-1/2", 5-1/4", 7", and 8-3/4"
 Weight.....108 lbs.
 Optional Shelf (1) S3, (1) S6
 Optional Grill Cover (S3 Shelf can not be used) (1) GC/B-2
 or Galvanized Grill Cover(1) GC/G-2
 Base Options B2 (Standard), B3, B4, B3G

/HP Option
Hot Plate Grate

Stainless Steel Grate on N-20, NS-20, and N/G-20 Grills



Model S6
Black Enamel Swivel Shelf



Model S3
Black Enamel Shelf
7" x 20"

Model S3/G
Hot Dip Galvanized Shelf

Model S3S
Stainless Steel Shelf

MULTILEVEL GRILL - Q Series



Model Q-20/S B2 Grill with tip-up grate and optional S3 shelf

- Two sizes: **Model Q-20** provides 300 sq. in., and **Model Q-24** provides 432 sq. in. of cooking area. Cook grate adjusts to four levels and tips up for easy fire building and clean up.
- Full 360° rotation in either direction on theft-proof swivel attachment. Standard 3-1/2" OD x 40" long base post for embedded installation (B2).
- All welded firebox construction includes 3/16" (7 ga.) thick steel, plus integral die-formed flanges to retain ashes and reinforce firebox from heat.
- All welded cooking grate construction: 5/8" dia. steel bars for support handles, 1/2" dia. steel bars for cooking surface. All grate bars are welded on both sides. Grate is permanently incorporated into firebox and cannot be removed. Grate tips up. Handle grips are 1/8" x 1/2" coiled steel bar.
- All components are finished with high temp non-toxic black enamel paint.
- **Optional:** Model Q-20 and Q-24 can be hot dip galvanized to include the firebox and post (example **Model Q/G-20 B2G**).
- **Optional:** Model Q-20 painted grill and Q/G-20 galvanized grill can be equipped with a stainless steel cooking grate (example: Q/S-20, Q/G/S-20).
- **Optional:** Model S3 bolt on shelf, or Model S3G galvanized shelf.
- **Optional:** Model S6 swivel shelf installs on 3-1/2" OD base post. This shelf can be used with grill cover. Painted finish only. See Page 108.
- **Optional:** Hinged grill cover on Model Q-20 or Model Q-24 (painted finish) or Q/G-20 and Q/G-24 (galvanized finish). Note: Model S3 bolt on shelf cannot be used with grill cover.

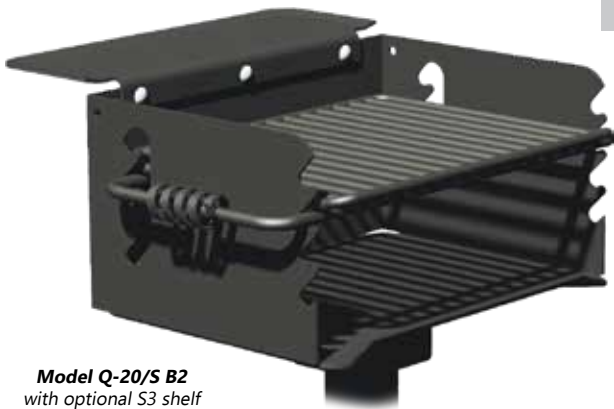

Model Q-20/S B2
with optional S3 shelf

Firebox Dimensions (D x W x H)..... 15" x 20" x 10"
 Cooking Area (Sq. In.)..... 300
 Finish.....High-temp Enamel
 Optional Finish..... (Firebox and B2 Post) Hot Dip Galvanized
 Grate Options..... (Q/S or Q/G/S) Stainless Steel
 Vertical Grate Adjustment from Bottom
 of Firebox..... 3-1/2", 5-1/4", 7", and 8-3/4"
 Weight.....80 lbs.
 Optional Shelf..... (1) S3, (1) S6
 Optional Grill Cover (S3 Shelf can't be used)..... (1) GC/B-1
 Optional Galvanized Grill Cover..... (1) GC/G-1
 Base Options..... B2 (Standard), B3, B4

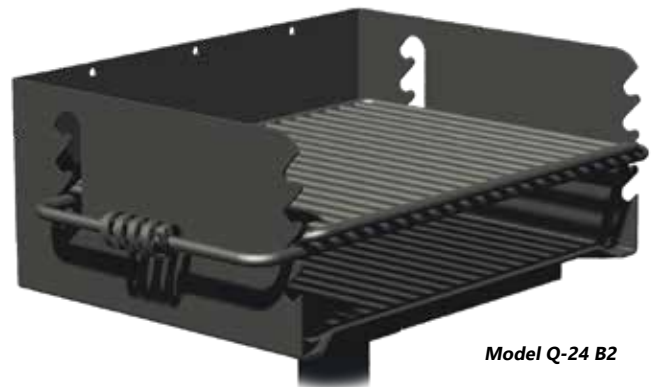

Model Q-24 B2

Firebox Dimensions (D x W x H)..... 18" x 24" x 10"
 Cooking Area (Sq. In.)..... 432
 Finish.....High-temp Enamel
 Optional Finish..... (Firebox and B2 Post) Hot Dip Galvanized
 Vertical Grate Adjustment from Bottom
 of Firebox..... 3-1/2", 5-1/4", 7", and 8-3/4"
 Weight.....108 lbs.
 Optional Shelf..... (1) S3, (1) S6
 Optional Grill Cover (S3 Shelf can't be used)..... (1) GC/B-2
 Optional Galvanized Grill Cover..... (1) GC/G-2
 Base Options..... B2 (Standard), B3, B4



Model B2
(Standard)
Embedded
Base



Model B3
Surface
Mount Base

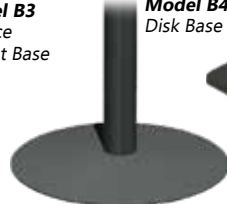

Model B4 Portable
Disk Base



Model S6
Swivel Shelf



Model S3/G
Hot Dip Galvanized Shelf



Model GC
Grill Cover for Model Q

CHARCOAL GRILLS



DOUBLE MULTILEVEL GRILL –

N2-2032 Series

- **Model N2-2032** charcoal grill provides a total of 600 sq. inches of cooking area on twin 300 sq. in. four level adjustable back-to-back cooking grates.
- Use one or both fireboxes, depending on the size of your group. Build different size coal fires depending on your menu. Each grate can be adjusted independently.
- All-welded grill firebox construction. The N2-2032 firebox is fabricated from 3/16" (7 ga.) thick steel, with integral die-formed flanges to retain ashes and to reinforce the firebox from heat warpage, plus a reinforcement ring under the entire firebox for additional strength.
- All welded cooking grate construction. The cooking grates are fabricated using 5/8" dia. steel bars for support handles, and 1/2" dia. steel bars for the cooking surface. All grate bars are welded on both sides. The cooking grate is permanently incorporated into each firebox and cannot be removed. Grate handle grips are 1/8" x 1/2" coiled steel bar.
- Full 360° rotation in either direction on theft-proof swivel attachment. The standard B2 embedded installation base post is 3-1/2" OD x 40" steel pipe.
- **Optional:** The standard B2 embedded base post can be replaced with B4 portable disc base, or B3 surface/bolt down base plate (anchor bolts are not included - use #ANC1-4 Concrete Anchor Kit), or B14 portable caster base.
- **Optional:** (1) or (2) Model S1 (7" x 9-5/8") bolt on side utility shelf, attached at the top/center of the firebox on one or both sides.
- **Optional:** (1) Model S2 (9" x 20") bolt on side utility shelf, attaches to reinforcement ring under firebox on one side only.
- **Optional:** Model N2-2032 can be equipped with twin stainless steel cooking grates (becomes Model N2/SS-2032).



Model N2-2032 B2 Grill with two cooking grates and two optional S1 shelves. Order shelves separately.



Model N2-2032 B2 with optional S1 and S2 shelves. Order shelves separately.



Model N2-2032 B2 Grill with two cooking grates and two optional S1 shelves. Order shelves separately.

Firebox Dimensions (D x W x H)	(2) 15" x 20" x 10"
Cooking Area (Sq. In.)	600
No. of Grates	2
Grate Options	(N2/SS) Stainless Steel
Vertical Grate Adjustment from Bottom of Firebox	3-1/2", 5-1/4", 7", and 8-3/4"
Weight.	141 lbs.
Optional Shelf (order separately)	(1 or 2) S1, (1) S2
Base Options	B2 (Standard), B3, B4, B14



Model B2
(Standard)
Embedded Base

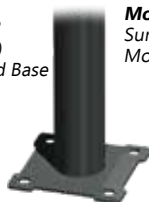

Model B3
Surface
Mount Base

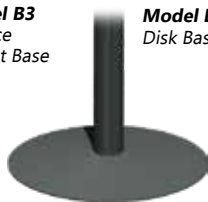

Model B4 Portable
Disk Base



Model S2
9" x 20" Shelf

Model S1
7-1/8" x 9-5/8"
Shelf



Stainless Steel Grate



MULTILEVEL GRILLS - H, J, or K Series



Model H-16 B6 multilevel grill.

- Cooking grate adjusts to 4 levels plus tips up for easy fire building and clean out. Grate stays permanently attached to firebox.
- Grill rotates 360 degrees in either direction on theft-proof swivel attachment to post. Model H stands on a 2-3/8" OD post (B6). Models J and K use a 3-1/2" OD post (B2).
- Welded construction: 3/16" thick (7 ga.) steel firebox with die-formed reinforcing flanges; 5/8" dia. steel perimeter and handle bars, 1/2" dia. grate bars. All grate bars are welded on both sides. High temp non-toxic black enamel paint finish.
- Side indentations support the grate in 4 locations and minimize side openings for superior draft protection. Coiled 1/8" x 1/2" steel bar handle grips for convenient grate adjustment.
- **Optional:** Model S3 bolt-on shelf on K-20 grill. Or Model S6 swivel shelf mounts on 3-1/2" OD base post on J-20 and K-20 grills.
- **Optional:** Model K-20 can be equipped with hinged grill cover.
- **Optional:** Model J-20 and K-20 can include 8" x 15" Hot Plate, replacing a portion of the bars in the cooking grate (e.g. becomes Model J-20/HP).



Model H-16 B6

Firebox Dimensions (D x W x H)	16" x 16" x 8"
Cooking Area (Sq. In.)	250
Vertical Grate Adjustment	
from Bottom of Firebox	2-1/2" to 7-3/4"
Weight	61 lbs.
Optional Shelf	None
Base Options	B6 (Standard), B17

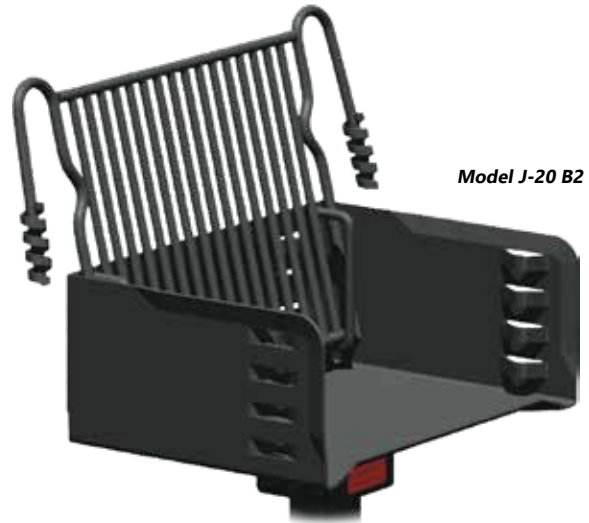

Model J-20 B2

Firebox Dimensions (D x W x H)	15" x 20" x 8"
Cooking Area (Sq. In.)	300
Vertical Grate Adjustment	
from Bottom of Firebox	2-1/2" to 7-3/4"
Weight	75 lbs.
Optional Shelf	S6
Base Options	B2 (Standard), B3, B4, B6, B17



Model K-20/S B2
with optional S3 shelf

Firebox Dimensions (D x W x H)	15" x 20" x 10"
Cooking Area (Sq. In.)	300
Vertical Grate Adjustment	
from Bottom of Firebox	4" to 9-1/4"
Weight	83 lbs.
Optional Shelf	(1) S3, (1) S6
Optional Grill Cover (S3 Shelf can't be used)	(1) GC/B-1
Base Options	B2 (Standard), B3, B4



Models B2 or B6 Embedded Base

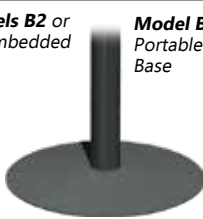

Model B4 Portable Disk Base



Model B3 or B17 Surface Mount Base



Model GC/B-1 Grill Cover for Model K-20 grill only



Model S6 Swivel Shelf



Model S3 7" x 20" Shelf

CHARCOAL GRILLS



COVERED GRILL - EC Series



(Above)
Model EC-40/S B2 covered grill with utility shelf and optional warming basket.
(Left)
Model EC-26/S B2, cover closed, showing handles, draft vents and clean out door.

- Covered Grills hold in smoke and heat. Covers also keep rain and snow out of firebox to prolong life of grill.
- Single level cooking grate is hinged to tip up for easy access to fire grate. Fire grate keeps coals off bottom of firebox. This provides better draft control and prolongs life of grill. The fire grate also tips up for easy ash clean out through side door.
- Four adjustable draft vents control fire and cooking rate. Full contact rear edge between bottom and cover provides draft control when lid is open. Continuous 360-degree rotation in either direction is provided on theft-proof swivel attachment to 3-1/2" OD x 40" long base post (B2) for embedded installation.
- Both firebox and cover have a 1" formed flange to provide flat, stable contact perimeter and to substantially reinforce grill halves. Slotted steel hinges allow cover to adjust to an obstruction, eliminating potential pinch points. Once fully open the cover is locked in place and cannot be closed without deliberate user action. Cover and grate handle grips are 1/8" x 1/2" coiled steel bar.
- All-welded construction. Heavy gauge steel is used for cover (14 ga.), bottom (10 ga.) and end panels (11 ga.). Cooking and fire grates are created using 1/2" dia. steel bar, with 5/8" dia. handle bars. All grate bars are welded on both sides. Unit is finished with high temp non-toxic black enamel paint.
- Each grill includes one Model S2 bolt-on utility shelf, 9" x 20".
- **Optional:** Model S6 swivel shelf available on EC-26 only. See Page 108.
- **Optional:** Portable, bolt down or caster bases.
- **Optional:** Warming Basket to hang inside top cover.



Model EC-26/S B2
with optional warming basket

Overall Dimensions without shelf (D x W x H)	19-1/2" x 29-1/4" x 16-1/2"
Cooking Area (Sq. In.)	320
No. of Grates	(1) Cooking, (1) Fire
Weight	137 lbs.
Optional Shelf	(1) S6
Base Options	B2 (Standard), B3, B4, B12, B14
Warming Basket (7" x 21" x 2")	ECB-26



Model EC-40/S B2
with optional warming basket

Overall Dimensions without shelf (D x W x H)	19-1/2" x 41-1/2" x 16-1/2"
Cooking Area (Sq. In.)	500
No. of Grates	(1) Cooking, (1) Fire
Weight	178 lbs.
Optional Shelf	None
Base Options	B2 (Standard), B3, B4, B12, B14
Warming Basket (7" x 33" x 2")	ECB-40



Model B2
Embedded Base

Model B12 2-wheel Caster Base



Model B3
Surface Mount Base

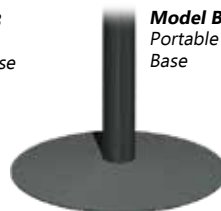

Model B4
Portable Disk Base



Model B14
4-wheel Caster Base



Model Q3-2460 B8 shelterhouse grill with standard surface mount base.

LARGE GROUP GRILL - Q3-2460 Series

- **Model Q3-2460 B8** group grill provides 1220 total sq. inches of cooking area on 3 grate surfaces.
- Firebox measures 24" x 60" x 10" high sides, constructed of 3/16" thick steel plate, rib reinforced to prevent box warpage.
- Cooking grate adjusts to 4 levels above the fire, is not removable from the firebox, includes dual protective coiled steel bar handle grips at both ends. Grate tips up for easy fire building and cleaning.
- Cooking grate is constructed of 5/8" dia. handle bars and 1/2" dia. grate bars. All grate bars are welded on both sides. Includes 1" wide steel full-length support brace under front edge of grate to prevent deformation.
- Total grate area is divided into three cooking chambers and is supported by four 3/16" thick steel panels.
- Base post is 6" OD heavy wall steel pipe with a 3/8" x 10" square base plate for surface installation (B8). Four 1/2" x 6" J-bolt anchors for concrete footing are included.
- Continuous 360 degree rotation on theft proof swivel attachment.
- Finished with high temp non-toxic black enamel paint.
- **Optional:** Embedded base post to replace bolt down base plate (B16).
- **Optional:** Model S7 bolt on shelf, 7 ga. steel, 10-5/8" x 59".

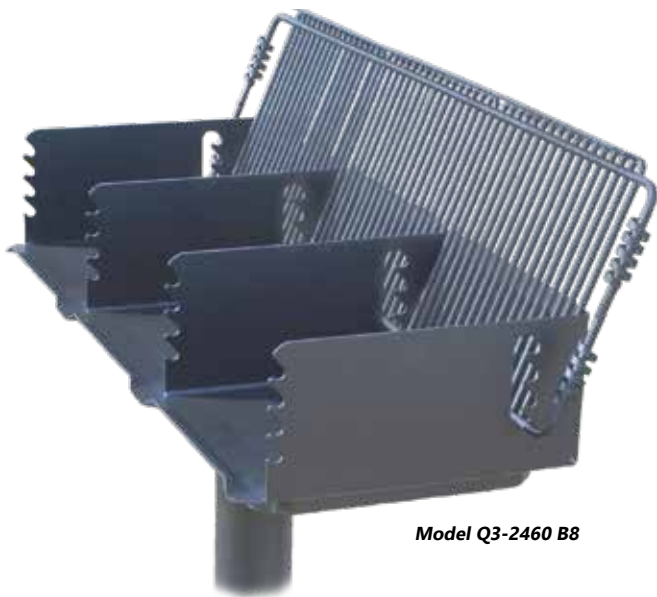

Model Q3-2460 B8



Model Q3-2460 B8 shelterhouse grill with standard surface mount base is great for large groups.

Firebox Dimensions (D x W x H).....	24" x 60" x 10"
Cooking Area (Sq. In.).....	1220
No. of Grates	(3) Cooking
Vertical Grate Adjustment from Bottom of Firebox	3-1/2", 5-1/4", 7", and 8-3/4"
Weight.....	.289 lbs.
Optional Shelf	S7
Base Options	B8 (Standard), B16



Model B16
Embedded Base



Model S7
7 ga. x 10-5/8" x 59"
Shelf,

Model B8
Surface Mount
Base (Standard)



Model GGS/B-1
Grill & Grate Scraper.

Model HCB-1
Hot Coal Bin



CHARCOAL GRILLS



LARGE GROUP GRILLS - P or L Series



(Left) **Model P-1000/S B7** shelterhouse grill.

(Below) **Model L-1500/SS B8** shelterhouse grill.



- **Model P-1000** offers 1008 sq. in. on twin 4-level adjustable cooking grates.
- **Model L-1500** offers 1350 sq. in. on twin single-level hinged cooking grates with a fire grate that adjusts to 4 levels under them.
 - Continuous 360-degree rotation on theft-proof swivel attachments. Model P-1000 stands on a 4-1/2" OD post; Model L-1500 stands on a 6" OD post. Both grills feature a 10" sq. bolt down plate installation onto a concrete surface. Four 1/2" x 6" J-bolt anchors included.
 - Both Models include (1) bolt on 10-5/8" x 36" steel utility shelf. Both grills have additional optional shelves.
 - Welded construction: 3/16" thick (7 ga.) steel firebox with die-formed reinforcing flanges, substantial gusseted bracing and ring reinforcement to help dissipate heat. Grates use 5/8" dia. steel perimeter and handle bars, and 1/2" dia. grate bars. All grate bars are welded on both sides. Entire grill is finished with high temp non-toxic black enamel paint.
- **Optional:** Portable caster base or embedded base to replace bolt down base plate.



Model L-1500/S B8 with one standard S4 shelf



Model P-1000/S B7 with one standard S4 shelf

Firebox Dimensions (D x W x H)..... 36" x 38" x 12"
 Cooking Area (Sq. In.)..... 1350
 No. of Grates (1) Fire, (2) Cooking
 Fire Grate Vertical Grate Adjustment
 from Bottom of Cooking Grate 4-15/16" to 10"
 Weight..... 430 lbs.
 Optional Shelves..... (1) S4 (Included), (1) Additional S4
 Base Options B8 (Standard), B11, B16

Firebox Dimensions (D x W x H)..... 28" x 36" x 10"
 Cooking Area (Sq. In.)..... 1008
 No. of Grates 2
 Vertical Grate Adjustment
 from Bottom of Firebox 3-3/4" to 9"
 Weight..... 215 lbs.
 Optional Shelves... (1) S4 (Included), (1 or 2) S1, (1) Additional S4
 Base Options B7 (Standard), B13, B15



Models B7 and B8 Surface Mount Bases (Standard)

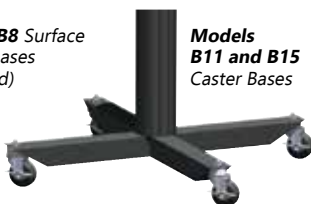

Models B11 and B15 Caster Bases



Model B13 and B16 Embedded Base



Model S1 7-1/8" x 9-5/8" Shelf



Model S4 10-5/8" x 36" Shelf

GRILL STATION - Your Grill and Work Table All In One



Model GS/CB-5PC Grill Station with black powder coated frame, cedar colored recycled plastic planks and optional Model Q-20-2 park grill.

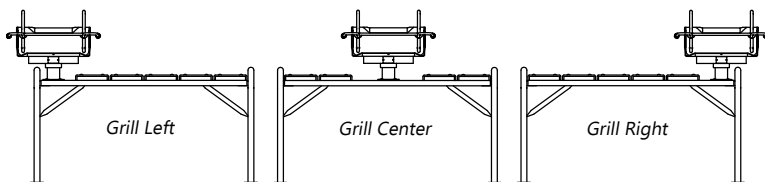

Your choice of grill can be installed at either end or in the center of the Grill Station.

• The Grill Station combines a Pilot Rock charcoal grill with a work table. No need for separate installations of a grill on a post and a utility table. Now it's all in one!

Model GS-5 Grill Station features include:

- **Rugged Construction:** 1-5/8" OD steel pipe end frames with welded-on brace and top frame bracket. Diagonal braces ensure a rigid, stable structure. Top frame is 1-1/2" Steel angle, welded into single component.
- **Frame Finish:** Hot dip galvanized is standard. Colorful powder coat paint is optional. *See Page 52.*
- **Table Top:** Built with (5) 2" x 10" (nom.) x 20" wide planks, plus (1) grill mount plate. Available table top materials include: untreated or treated pine, colorful recycled plastic, and clear anodized or powder coated aluminum. *See Pages 53-54.*
- **Footprint:** Grill Station is 22-1/2" by 64" (nom.) overall outside dimensions (does not include grill).
- **Work Space:** 20" wide by 48" long (when grill is at one end).
- **Work Height:** Table height = 30-1/2"; Grill height = 36" to bottom of firebox (charcoals). Cooking grate height will vary depending on grill model chosen.
- **Grill Mount:** The grill can be installed at either end or in the center. (Note: a center location will reduce table top space to 2 planks per side.) The theft proof swivel attachment allows the grill to rotate 360 degrees for maximum cooking control.
- **Installation:** Surface mount flanges on each frame leg. Anchor bolt kit #ANC3-4 for a concrete surface is included.
- **Grill Choices:** The Pilot Rock charcoal grill is sold separately. See Chart below.
- **Optional:** 2-part aluminum cover caps for frame posts. *See Page 26.*

GRILL CHOICES FOR MODEL GS-5 GRILL STATION

Model	Cooking Area	Catalog Page(s)	Model	Cooking Area	Catalog Page(s)	Model	Cooking Area	Catalog Page(s)
ASW-20-2	300	96-97	N-20-2	300	100-101	J-20-2	300	104
ASW-24-2	360	96-97	N-24-2	432	100-101	K-20-2	300	104
A-20-2	320	98-99	Q-20-2	300	102	EC-26/S-2	320	105
B-24-2	384	98-99	Q-24-2	432	102			

SWIVEL SHELF

- **Model S6 Swivel Shelf** (8" x 16") option for select Pilot Rock grills installs on the 3-1/2" OD base post (must be installed prior to firebox and locking pin). The shelf will swivel 360 degrees around the post, independently of the grill firebox. Finished with black enamel paint.
- Model S6 Swivel Shelf will fit on the following Pilot Rock Grills: ASW-20, ASW-24, A-20, B-24, N-20 (shown below), N-24, Q-20, Q-24, J-20, K-20, and EC-26 (shown below). (This option is not available on EC-40 Grills.)



Model EC-26 Covered Grill with optional S6 swivel shelf.



Model N-20 Grill shown with optional Grill Cover and optional S6 swivel shelf.

Model	Page(s)
ASW-20	96-97
ASW-24	96-97
A-20	98-99
B-24	98-99
N-20	100-101
N-24	100-101
Q-20	102
Q-24	102
J-20	104
K-20	104
EC-26	105

CHARCOAL GRILLS



HOT COAL DISPOSAL BIN



Model HCB/B-1
Hot Coal Bin
for coal
and ash disposal.



Model HCB/B-1 Hot Coal Bin
with black high temp enamel top.
Shown with door open to show optional
garbage can.

- **Model HCB/B-1** Hot Coal Bin is a convenient, economical, safe way to dispose of hot coals and ashes from grills, and help prevent the dumping of hot coals on the ground.
- The 23" square top funnels down to a 12" square grated opening. The grate bar spacings will allow full size charcoal briquettes through, but will restrict most large trash. A full-length piano hinge attaches the door to one side panel. The draw-pull door latch can be padlocked to keep other trash and vandals out.
- Inside place any size steel container up to a 32-gallon capacity garbage can (not included).
- **OR:** Anchor Bin to a concrete pad. The ashes collect on the concrete pad inside the Bin. To clean out, open the door and scoop out the ashes with a flat shovel.
- The Hot Coal Bin also serves as a convenient depository for park maintenance personnel to dump ashes as they clean out pedestal grills. Picnickers can also use it when done grilling.
- Two anchor methods: Order optional Model M9/B ground anchor stakes to secure the Bin on top of the ground (this requires a steel collection can inside); or for anchoring Bin to concrete surface order Model BR-4HSA anchors.
- **Features:** Bin measures 23" x 23" x 32-1/2" tall, fabricated from 1/16" (14 ga.) steel for the side panels and top funnel, 1/2" dia. steel bars for the grate, **high temp black enamel paint**, includes (2) DE-20 "caution" decals, ships unassembled, galvanized fasteners included.
- **Optional:** Powder coat paint finish on side panels and door (not high heat). See Page 52.
- **Optional:** See available options below.



Model HCB/CR-1
Hot Coal Bin with
optional red powder
coat paint finish
(not high heat).



Model PL-1 Brass Padlock



Model CNG-2310C
31 gallon galvanized steel can



Model M9/B Ground Anchors, set of (3).

Model BR-4HSA set of (4) 3/8" x 1-7/8" hex sleeve concrete anchors (not shown).



Model GGS/B-1
Grill & Grate Scraper.



Model CNG-W10120
12 quart galvanized steel collection pail

GRILL OPTIONS AND ACCESSORIES



Embedded



Surface Mount



Portable, Four Casters



Portable, Two Casters, Two Pads

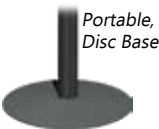

Portable, Disc Base



Bolt-on



Swivel, Mounts on Base Post, must be installed before grill



GRILL BASES				
Model	O.D. & Length	Style	Finish	Use with these grills
B2	3-1/2" x 40"	Embedded	Black Enamel Paint	Standard on A-20, B-24, C2-36, D2-48, N-20, N-24, Q-20, Q-24, J-20, K-20, EC-26, EC-40, ASW-20, ASW-24, N2-2032
B2G	3-1/2" x 40"	Embedded	Pre Galvanized	Standard on N/G-20, N/G-24
B6	2-3/8" x 40"	Embedded	Black Enamel Paint	Standard on H-16, Optional on J-20
B6S	2-3/8" x 40"	Embedded	Stainless Steel	Standard on NS-20, ASWS-20, ASWS-24
B13	4-1/2" x 40"	Embedded	Black Enamel Paint	P-1000
B16	6" x 40"	Embedded	Black Enamel Paint	Q3-2460, L-1500
B3	3-1/2" x 26-7/8"	Surface Mount 1/4" x 8" x 8" Plate	Black Enamel Paint	A-20, B-24, C2-36, D2-48, N-20, N-24, N/G-20, N/G-24, N2-2032, Q-20, Q-24, Q/G-20, Q/G-24, J-20, K-20, EC-26, EC-40
B17	2-3/8" x 26-7/8"	Surface Mount 1/4" x 8" x 8" Plate	Black Enamel Paint	H-16, J-20
B17S	2-3/8" x 26-7/8"	Surface Mount 1/4" x 8" x 8" Plate	Stainless Steel	NS-20
B7	4-1/2" x 27"	Surface Mount 3/8" x 10" x 10" Plate	Black Enamel Paint	Standard on P-1000
B8	6" x 27"	Surface Mount 3/8" x 10" x 10" Plate	Black Enamel Paint	Standard on Q3-2460, L-1500
B18	3-1/2" x 24-3/8"	Surface Mount 1/4" x 8" x 8" Plate	Black Enamel Paint	ASW-20, ASW-24
B19S	2-3/8" x 24-3/8"	Surface Mount 1/4" x 8" x 8" Plate	Stainless Steel	ASWS-20, ASWS-24
B11	6" x 28-9/16"	Portable, Four Casters	Black Enamel Paint	L-1500
B12	3-1/2" x 28-1/2"	Portable, Two Casters, Two Pads	Black Enamel Paint	EC-26, EC-40
B14	3-1/2" x 28-9/16"	Portable, Four Casters	Black Enamel Paint	C2-36, D2-48, N2-2032, EC-26, EC-40
B15	4-1/2" x 28-9/16"	Portable, Four Casters	Black Enamel Paint	P-1000
B4	3-1/2" x 25-11/16"	Portable, Disc	Black Enamel Paint	A-20, B-24, C2-36, D2-48, N-20, N-24, N/G-20, N/G-24, N2-2032, Q-20, Q-24, Q/G-20, Q/G-24, J-20, K-20, EC-26, EC-40

GRILL SHELVES				
Model	Dimensions	Style	Finish	Use with these grills
S1	7-1/8" x 9-5/8"	Bolt-on	Black Enamel Paint	A-20, B-24, C2-36, P-1000, N2-2032
S2	9" x 20"	Bolt-on	Black Enamel Paint	D2-48, N2-2032, Included on EC-26 & EC-40
S3	7" x 20"	Bolt-on	Black Enamel Paint	N-20, N-24, Q-20, Q-24, K-20
S3/G	7" x 20"	Bolt-on	Hot Dip Galvanized	N/G-20, N/G-24, Q/G-20, Q/G-24
S3S	7" x 20"	Bolt-on	Stainless Steel	NS-20, NS/S-20
S4	10-5/8" x 36"	Bolt-on	Black Enamel Paint	(1 Included, 1 Optional) L-1500 & P-1000
S6	8" x 16"	Swivel Mount on base Post <i>(Install before grill)</i>	Black Enamel Paint	A-20, B-24, N-20, N/G-20, N-24, N/G-24, Q-20, Q/G-20, Q-24, Q/G-24 J-20, K-20, EC-26, ASW-20, ASW-24
S7	10-5/8" x 59"	Bolt-on	Black Enamel Paint	Q3-2460

GRILL COVERS	
Model	Use with these grills
GC/B-1	N-20, Q-20, K-20
GC/G-1	N-20, N/G-20, NS-20, Q-20, Q/G-20
GC/B-2	N-24, Q-24
GC/G-2	N-24, N/G-24, Q-24, Q/G-24

Hot Plate Grate, /HP



Stainless Steel Grate, /S

OPTIONAL COOKING GRATES	
Model	Use with these grills
/HP	N-20, N/G-20, J-20, K-20
/S	N-20, N/G-20, NS-20, Q-20, Q/G-20, N2-2032

MAINTENANCE TIPS FOR CHARCOAL GRILLS & CAMPFIRE RINGS

Firebox Rust - Grills

The non-toxic, high heat paint on the grill/firebox will last one to two years depending on frequency of use and size of fire. When there are signs of rusting anywhere on the firebox, use a wire brush to clean the areas and then spray or brush apply another coat of high heat, non toxic enamel paint. Do this ONLY when there is no fire in your grill and ONLY when the unit has cooled down to air temperature.

The most common maintenance issue with park grills is rust out at the bottom of the firebox. This occurs where the charcoal fire burns the paint off. When the center of the firebox is compromised by rust, the entire grill can become unusable. This will take a long time to happen, but the problem can be easily minimized to add years to the life of the grill.

The rusting process is accelerated where the used coals and ash are left sitting on the bottom of the firebox. A little rain added to these ashes will create a mixture that is corrosive to steel. Regularly clean out the used coals and ash from the grills. (Use our Model GGS/B-1 Grill and Grate Scraper tool or other similar tools.) At the end of each park and camp season, you should consider wire brushing and repainting the bottom of the firebox to protect against rusting through the off-season months.



Cooking Grate Rust - Grills & Campfire Rings

On new grills and campfire rings, the cooking grate should be seasoned before grilling directly on the steel grate. You can season the grate by gradually burning the high heat non-toxic paint off the grate bars as you use the grill. Before you heat the grate each time, you can use a wire brush to clean the grate and remove any paint chips. Until the grate is seasoned, you can use aluminum foil to cover the grate bars, or cook in a metal pan or pot.

The cooking grate bars will also rust over time. This is not usually a problem on grates that are used often because the grease and oils from grilled foods coat the grate bars. The grate bars on Pilot Rock charcoal grills and firerings are solid steel, so it will take years for rust to become a problem. Periodic cleaning is still a good idea. Simply scrape the bars clean with the Model GGS/B-1 Grill and Grate Scraper. Any rusted spots can be cleaned with a wire brush.

A used grate should be cleaned and prepared before the next use. Clean it with the Grill and Grate Scraper and a wire brush to remove any rust. Then thoroughly heat the grate by keeping it low and close to the coals. Finally, raise the grate and scrape it clean again. Alternatively, the grate can be covered with aluminum foil before cooking on it again, or use a pot or skillet to cook food.

Swivel Post Connection Rust - Grills

All Pilot Rock charcoal grills include a swivel post connection to the firebox. This allows you to turn the firebox 360 degrees in either direction to compensate for wind. It is a steel to steel connection. Even underneath the firebox, rusting will eventually occur. If the grills are used and turned regularly, there should be minimal problems. This connection can't normally be lubricated because of the heat from the coals in the firebox. If the grill sits idle during the off-season, occasionally rotate each firebox on its post to break any rust bond that might be forming. Lubrication can also be utilized in the off-season to minimize issues with rust.



Ring Rust - Campfire Rings

The steel fire ring will begin to rust as the paint coating is burned off over time. The rust on the steel ring is mostly a cosmetic issue. To touch up the paint, remove all ashes and coals from the fire ring. Then use a wire brush to remove as much rust as possible. Apply a coat of high heat enamel paint. You can paint both the inside and outside surfaces. This will protect the steel ring during the off-season and will prolong the life of the ring.

Ashes will accumulate inside the steel ring. These ashes and moisture will create a mixture that is corrosive to the steel. Ashes must be scooped out of the firering regularly to prolong the life of the steel.

Pilot Rock campfire rings are designed to sit directly on top of the ground. However, a popular installation alternative is to encircle the steel ring with landscaping blocks or stones. Ashes and other debris can accumulate on both sides of the steel ring. This means the steel ring can now be subjected to ash and moisture on both sides at the same time.

A similar installation is when the steel ring is buried into the ground. The steel ring is now exposed to constant ground moisture on the outside and corrosive ashes and moisture on the inside. This installation can significantly increase the rusting of the steel ring. This installation is not covered by warranty.

CAMPFIRE RING - FX Series

- When you need the fire barrier only, **without the cooking grate**.
- Our **FX Series** Campfire Rings provide a solid steel fire barrier, and do not include the cooking grate.
- Perfect when you don't plan to cook over the fire, but you need the barrier to control the fire and protect the property or your landscape blocks.*
- The steel ring is rolled from 3/16" thick steel plate with an integral formed 1" wide flange around the top edge. This flange provides extra strength against heat warpage and eliminates a vertical edge. Draft holes are provided for fire ventilation.
- FX Series Campfire Rings are available in 4 different diameters and 4 different side heights (see chart below for dimensions). Select the diameter to control the fire size, and the side height to achieve the degree of fire barrier needed.
- All FX Series fire rings come with anchors. Tip back anchor pins (TB) available on some models keep the ring secured in one place, but allow the ring to tip up for easy clean out. Other stationary anchor systems include angle legs (AL) and pin anchors (PA) keep the ring securely on the ground. *See Page 125.* Refer to the chart below to see which anchor method is available on each fire ring.
- **Optional:** Bolt on utility shelf Model S5. *See Page 124.*
- **Optional:** Removable Drop-In Grate Model DIG-U4. *See Page 122.*
- **Optional:** Snuffer Cover protects fire ring from the elements and suffocates fires. *See Page 123.*

Model	Inside Diameter	Side Height	Anchor System	Cooking Area (Sq. In.)
FX-26/7/TB	24"	7-3/8"	TB (Standard), AL, TA (Optional), TB-BD (FX-30 only). <i>See Page 125</i>	No Cooking Grate
FX-30/7/TB	30"	7-3/8"		
FX-30/9/TB		9"		
FX-30/11/TB		11-3/8"		
FX-48/7/PA	46"	7-3/8"	PA (Standard), AL (optional). <i>See Page 125</i>	
FX-48/9/PA		9"		
FX-48/11/PA		11-3/8"		
FX-56/7/PA	54"	7-3/8"		
FX-56/9/PA		9"		
FX-56/11/PA		11-3/8"		
FX-30/18/PA	30"	16-7/8"		

***Note:** FX firerings without anchors can be used as fire pit inserts. Consult your local block supplier for which block will be best to construct a fire pit with the necessary inside diameter to fit your selected firering.



Model FX-30/11/TB campfire ring in it's simplest form, with no grate.



Model FX-30/11/TB campfire ring with optional Model DIG-U4 Drop-in cooking grate.



Model FX-30/11/TB campfire ring with optional Model CFX-30 Snuffer Cover.



Picnic Tables (Pages 28-51) are handy to have near campfire rings to provide a comfortable area where campers can sit and enjoy their freshly cooked meal.

CAMPFIRE RING - FA Series



Model FA-30/7/TB campfire ring, 7-3/8" tall.



Model FA-30/7/TB showing cooking grate being tipped over and out of firering.

- **The FA Series** Campfire Rings offer our original **Ininitely Adjustable cooking grate**.
- 270 sq. inch cooking grate is Ininitely Adjustable vertically from below the top of the ring to 7-3/4" higher. This cantilevered grate is structurally reinforced to resist hard use and vandalism.
- The cooking grate can be lifted over and out of the ring, but remains permanently attached.
- Ring is rolled from a 3/16" thick steel plate with an integral formed 1" wide flange around top edge. This flange provides extra strength against heat warpage and eliminates a vertical edge. Draft holes are provided for fire ventilation.
- **FA Series** Campfire rings come in two different diameters and 4 different side heights (see chart below). Select the diameter to control the size of fire, and the side height to achieve the degree of fire barrier needed.

- **FA Series** firerings include tip back anchor pins (standard) to keep the ring secured, but allow the ring to tip up for easy clean out. For other anchor systems, *see page 125*.
- Cooking grate adjustment handles, made from 3/4" dia. steel, are turned outside of the ring, away from the fire. The handle grips are 1/8" x 1/2" coiled steel bar. The cooking grate is built using 5/8" dia. steel perimeter bars and 1/2" dia. steel grate bars. All grate bars are welded on both sides.
- **Model FA-30/18** combines our Ininitely Adjustable cooking grate with a taller ring, providing a more comfortable working height. The elevated design allows placement flexibility because the aggregate fill (not included) protects existing surfaces such as pavers, asphalt and concrete. This fill also insulates the ground to reduce the chance of root fires in heavily wooded areas.
- Finished with high temp, non-toxic black enamel paint.
- **Optional:** Bolt on utility shelf Model S5. *See Page 124.*
- **Optional:** Heat shield, welded on. *See Page 124.*

FA Side Heights

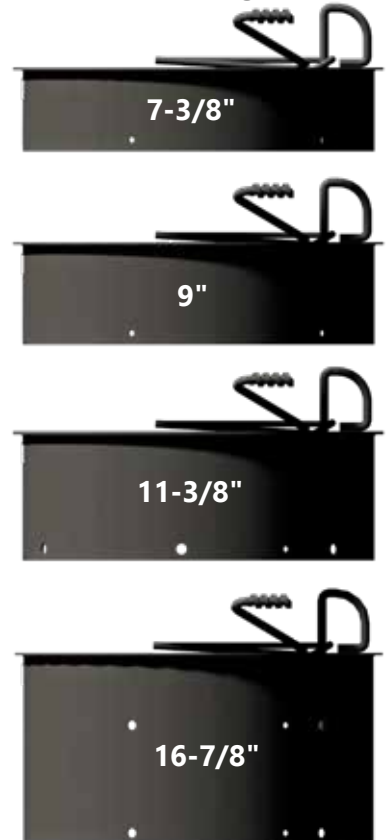

Model FA-30/18/S fire ring with optional shelf. (Note: anchor pins not used in this installation).

Model	Inside Diameter	Side Ht.	Anchor Systems	Cooking Area (Sq. In.)	Vertical Grate Adj, (in.)
FA-26/7/TB	24"	7-3/8"	TB (Standard), AL, TA (Optional), TB-BD (FA-30 only). <i>See Page 125</i>	270	7-3/4
FA-30/7/TB	30"	7-3/8"			
FA-30/9/TB		9"			
FA-30/11/TB		11-3/8"			
FA-30/18/PA			16-7/8"	PA (Standard), AL (Optional) <i>See Page 125</i>	

CAMPFIRE RING - FS Series



Model FS-30/7/TB campfire ring, 7" tall.



Model FS-48/9/PA campfire ring, 9" tall.

- The **FS Series** Campfire Rings provide a **single level cooking grate** with our flanged fire ring – an economical design when cooking over the fire might be a lower priority.
- 290 sq. inch single level cooking grate is hinged to the ring and remains permanently attached.
- Ring is rolled from 3/16" thick steel plate with an integral formed 1" wide flange around top edge. This flange provides extra strength against heat warpage and eliminates a vertical edge. Draft holes are provided for fire ventilation.
- **FS Series** Campfire Rings are available in 4 different diameters, and up to 3 different side heights (see chart below, right). Select the diameter to control the size of fire, and the side height to achieve the degree of fire barrier needed.
- Tip back anchor pins (standard) keep the ring secured in one place, but allow the ring to tip up for easy clean out. Other anchor systems available. *See Page 125.*
- Cooking grate adjustment handles, made from 3/4" dia. steel, reach outside of the ring, away from the fire. The handle grips are 1/8" x 1/2" coiled steel bar. The cooking grate is built using 5/8" dia. steel perimeter bars and 1/2" dia. steel grate bars. The grate hinges are formed using 5/8" dia. steel bar. All grate bars are welded on both sides.
- Finish: high temp, non-toxic black enamel paint.
- **Optional:** Utility shelf Model S5. *See Page 124.*

FS Outside Diameter (at flange)

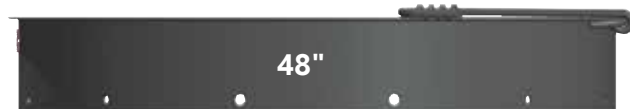

Model FS-30/9/TB campfire ring, 9" tall. Grate tips out for easy fire building!

Model	Inside Diameter	Side Ht.	Anchor Systems	Cooking Area (Sq. In.)
FS-26/7/TB	24"	7-3/8"	TB (Standard), AL, TA (Optional), TB-BD (FS-30 only). <i>See Page 125</i>	290
FS-30/7/TB	30"	7-3/8"		
FS-30/9/TB		9"		
FS-30/11/TB		11-3/8"		
FS-48/7/PA	46"	7-3/8"	PA (Standard), AL (Optional) <i>See Page 125</i>	290
FS-48/9/PA		9"		
FS-48/11/PA		11-3/8"		
FS-56/7/PA	54"	7-3/8"		
FS-56/9/PA		9"		
FS-56/11/PA		11-3/8"		



Model FSW-30/9/TB campfire Ring, 30" ID x 9" tall (nom.) with 300 sq. in. swivel cooking grate.

CAMPFIRE RING - FSW Series

- The **FSW Series** Campfire Rings combine a **single level swivel cooking grate** with our flanged fire ring.
- The Swivel Grate design meets the ADA guidelines for one hand operation and requires less than 5 lbs. of force to move. The 300 sq. in. single level Swivel Grate will move 180 degrees - from over the fire to completely out of the firering - for easy fire building and serving. The handle is never over the fire.
- This Swivel Grate is available on a variety of standard (*see chart below*) and wheelchair accessible models (*see Page 119*).
- The cooking grate is a single, welded component using 1/2" dia. steel bars, mounted on a 2-3/8" OD steel tube allowing it to swivel 180 degrees. The 5/8-inch dia. operator handle includes a 1/8" x 1/2" flat bar coiled spring grip. All grate bars are welded on both sides. All firerings are finished with high temp, non-toxic black enamel paint.
- **Optional:** Model S5 bolt on utility shelf is available on most campfire rings. *See Page 124.*
- **Optional:** Heat Shields available on some taller firerings. *See Page 124.*

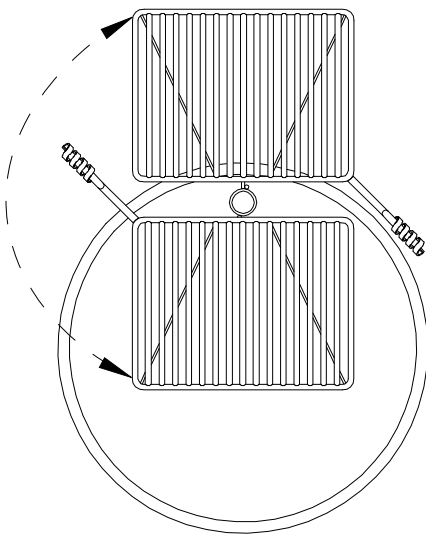

The swivel cooking grate on FSW campfire rings rotates 180 degrees from over the fire to completely outside of the fire ring. The handle is never over the fire due to its location and the direction of rotation.



Model FSW-30/9/TB campfire ring, 30" ID, with 300 sq. in. swivel grate. The cooking grate can be rotated 180 degrees to the outside position and the handle is never over the fire!



Model FSW-30/7/TB campfire ring, 7" tall.

Model	Inside Diameter	Side Ht.	Heat Shield Available	Anchor Systems	Swivel Cooking Grate Area (Sq. In.)
FSW-26/7/TB	24"	7-3/8"	No	TB (Standard), AL, TA (Optional), TB-BD (FSW-30 only). <i>See Page 125</i>	300
FSW-30/7/TB	30"	7-3/8"			
FSW-30/9/TB		9"			
FSW-30/11/TB		11-3/8"	Yes		
FSW-48/7/PA	46"	7-3/8"	No	PA (Standard) AL Optional <i>See Page 125</i>	
FSW-48/9/PA		9"			
FSW-48/11/PA		11-3/8"			
FSW-56/7/PA	54"	7-3/8"			
FSW-56/9/PA		9"			
FSW-56/11/PA		11-3/8"			

MULTILEVEL CAMPFIRE RING - L Series



Model L-32/6/TB campfire ring, 6" tall.

Model	Inside Diameter	Side Ht.	Anchor Systems	Cooking Area (Sq. In.)
L-32/6/TB	30"	6-1/4"	TB (Standard), TA (Optional), TB-BD (Optional). See Page 125	300
L-32/9/TB		9"		
L-32/11/TB		11"		

- **Model L-32** features a 300 sq. inch **cooking grate that adjusts to 4 levels**, from 2" to 8" above the ring height. Construction includes 3/16" thick steel for the ring and adjustment panels. The 1" formed flange reinforces the ring. The cooking grate is welded together using 5/8" dia. handle/support bars with coiled steel grips, and 1/2" grate bars. All grate bars are welded on both sides.
- Tip back anchor pins secure the ring in place but allow it to tip up for easy clean up.
- Finished with high temp, non-toxic black enamel paint.
- **Optional:** Bolt on utility shelf Model S5. See Page 124.
- **Optional:** Model RL-35 and RL-36 steel riser platforms for L-32/6 firing. Combined units are wheelchair accessible. Hard surface installation (anchors not included). Use #ANC1-4 anchor kit. See Page 126.



Model L-32/11/TB campfire ring, 11" tall. Shown with optional Model S5 utility shelf.

LARGE GROUP CAMPFIRE RING - O Series

- **Model O-34** is a large firering that offers a choice: build a large campfire in the front section, or build a smaller cooking fire under the grate. Built for large groups, the ring includes a 510 sq. inch single level cooking grate, hinged to tip over the fire or out of the ring. Cooking height is 9".
- The ring is built from 1/4" thick steel plate reinforced with a 3/16" x 1-1/4" angle iron.
- The cooking grate assembly includes: 1/4" thick flat steel bar perimeter frame; 1/2" dia. grate bars; 5/8" dia. handle bar with coiled steel bar grips. Tip back anchor pins secure the unit in place.
- Finished with high temp, non-toxic black paint.



Model O-34/TB large group campfire ring.



Model O-34/TB campfire ring. Grate tips out for easy fire building and cleaning!

Model	Inside Dimension	Side Ht.	Anchor Systems	Cooking Area (Sq. In.)
O-34/TB	34 x 40"	6"	TB (Standard), TA (Optional) See Page 125	510



SNOW LOAD RATED FIRERING - FSW/SL Series

- Our Swivel Grate firering design is tested to withstand snow loads of over **569 lbs. per sq. ft.** on the grate. The swivel grate is laser cut from 1/4-inch thick steel plate. A special 10 ga. channel brace is welded inside the ring to reinforce the swivel tube.
- This Swivel Grate design meets the ADA guidelines for one hand operation and requires less than 5 lbs. of force to move. The 300 sq. in. single level grate will move 180 degrees – from over the fire to completely out of the fire ring – for easy fire building and serving. The handle is never over the fire.
- The snow load rated Swivel Grate is available on several standard and wheelchair accessible height campfire rings. See chart below.
- The 5/8-inch dia. operator handle is welded on and includes a 1/8" x 1/2" flat bar coiled grip.
- All fire ring components are finished with a high temp non toxic black enamel paint.
- **Optional:** Model S5 bolt on utility shelf is available on most campfire rings. See Page 124.
- **Optional:** Heat Shields available on some taller firerings. See Page 124.



Detail of **Model FSW/SL-30** snow-loaded swivel grate and channel brace.



Model FSW/SL-30/9/PA Campfire Ring, 30" ID x 9" tall (nom.) with 300 sq. in. snow load rated swivel cooking grate.



Model FSW/SL-30/18/PA Campfire Ring, 18" tall (nom.) with snow load rated swivel cooking grate.

Model	Inside Diameter	Side Ht.	Wheelchair Accessible Height	Heat Shield Available	Anchor Systems	Swivel Cooking Grate Area (Sq. In.)
FSW/SL-30/7/TB	30"	7-3/8"	No	No	TB (Standard), AL, TA (Optional), TB-BD (Optional). See Page 125	300
FSW/SL-30/9/TB		9"		No		
FSW/SL-30/11/TB		11-3/8"		Yes		
FSW/SL-30/18/PA		16-7/8"	Yes	Yes	PA (Standard) AL (Optional) See Page 125	
FSW/SL-30/24/PA		23-3/8"		Yes		
FSWDW/SL-30/18/TB (double-wall)	26-3/8"	17-3/8"		No	TB only	

ADA Guidelines for Campfire Rings



The Final Guidelines for Federal Outdoor Recreation Sites include reach and operability specifications for campfire rings as follows:

- 1011.5.1 Fire Building Surfaces:** Fire building surfaces shall be 9 inches minimum above the ground.
- 1011.5.2 Cooking Surface:** Where provided, cooking surfaces shall be 15 inches minimum and 34 inches maximum above the ground.
- 1011.5.3 Raised Edges or Walls:** Where fire rings are constructed with raised edges or walls, the depth of the raised edge or wall shall be 10 inches maximum.
- 309.4 Operation:** Operable parts shall be operable with one hand and shall not require tight grasping, pinching or twisting of the wrist. The force required to activate operable parts shall be 5 pounds maximum.

R.J. Thomas Mfg. builds a variety of wheelchair accessible and ADA compliant campfire rings. We build our campfire rings to withstand the use and abuse of public campgrounds. On most firerings the cooking grate is designed to be indestructible (two people could stand on it without deformation), but this makes it too heavy for 309.4. Our Model FSW-30/18/PA campfire ring scores highest on all points of accessibility. The swivel grate is lighter weight, meets all the requirements of 309.4, but could suffer damage if abused.

Our different accessible campfire rings are designed to meet the different requirements of your installations.

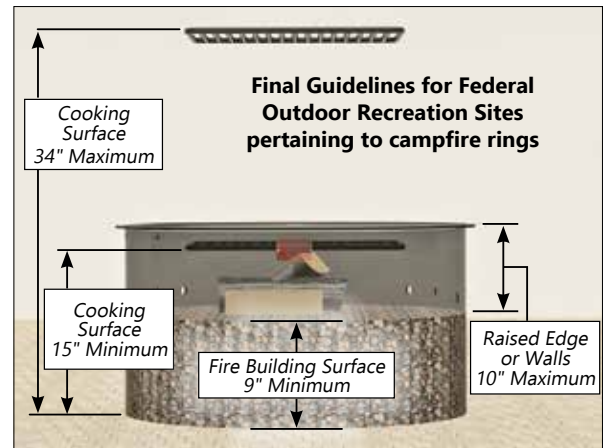

ACCESSIBLE CAMPFIRE RING - M Series

- **Model M-32** accessible campfire ring features a flat rear panel so wheelchairs can have closer access to the cooking grate and adjustment handles. The 300 sq. inch **cooking grate adjusts to 4 levels** between 19" and 24" above the ground. This design allows the grate to be adjusted one side at a time, using only one hand, and does not exceed 10 lbs. to lift.
- 3/16" thick steel ring, with 1" formed flange for safety and strength. The adjustment panels are cut from 3/16" steel, and also serve as heat shields.
- 300 sq. in. cooking grate is all welded 1/2" dia. steel bars supported by 5/8" dia. handle bars. 1/8" x 1/2" coiled flat steel bar handle grips. All grate bars are welded on both sides.
- Finished with high temp, non-toxic black enamel paint.
- Pin anchors provide a fixed location.
- The ring is filled with aggregate (not included) to about 10-1/2" deep to provide the elevated fire surface. This fill also insulates the ground to reduce the chance of root fires in heavily wooded areas. Drain/draft holes are provided around the perimeter of the ring.
- **Optional:** Bolt on utility shelf Model S5. *See Page 124.*
- **Optional:** Heat shield, welded on. *See Page 124.*



Model M-32/17 accessible firering
(Note: this installation did not require use of pin anchors).

Model	Inside Diameter	Side Ht.	Anchor Systems	Cooking Area (Sq. In.)
M-32/17/PA	30"	16-3/8"	PA only <i>See Page 125</i>	300

ACCESSIBLE CAMPFIRE RING - LDW Series



Model LDW-36/18/PA Double Wall Firering with four level adjustable grate and pin anchors. 18" high fire barrier.

- **Model LDW-36/18/PA** accessible campfire ring features a flat rear panel so wheelchairs have closer access to the cooking grate and adjustment handles.
- Accessible double-wall campfire ring Model LDW-36/18/PA includes a **full-height outer ring to serve as a heat barrier** for the inner ring. It also features a 300 sq. inch **four level adjustable cooking grate**.
- 1/8" (10 ga.) outer ring with 1" formed top flange; 3/16" (7 ga.) inner ring; 17-3/8" tall fire barrier.
- Three formed steel angles welded between rings form a 2" wide air space. Both rings include a series of 1" dia. (nom.) drain/draft holes. 3/16" thick steel panels support the cooking grate in four locations and help shield grate handles from heat.
- 300 sq. in. cooking grate is all welded 1/2" dia. steel bars supported by 5/8" dia. handle bars. 1/8" x 1/2" coiled flat steel bar handle grips. All grate bars are welded on both sides.
- Includes three anchor pins (/PA) to secure ring in place. Requires aggregate fill to raise the firebed. This firering does not have a firegrate.
- Finished with high temp, non-toxic black enamel paint.
- **Optional:** Bolt on utility shelf. *See Page 124.*
- **Optional:** Spade anchors (/AL), bolt on. Requires aggregate fill to raise the firebed.

Model	Inside, Outside Diameter	Side Ht.	Anchor Systems	Cooking Area (Sq. In.)
LDW-36/18/PA	31-3/4", 36-1/2"	17-3/8"	PA <i>See Page 125</i>	300
LDW-36/18/AL			AL <i>See Page 125</i>	

ACCESSIBLE CAMPFIRE RING

- FS & FSW Series

- The 290 sq. inch FS Series **single level grate** can be laid over the fire, or tipped over and out of the firering, but it remains permanently hinged to the ring. This taller ring, available in 18" or 24" tall designs, brings the cooking surface to a convenient height for use from a wheelchair.
- 3/16" thick steel, with 1" formed flange for strength and safety. The cooking grate uses a 3/4" dia. handle bar, 5/8" dia. perimeter bar and 1/2" dia. grate bars, and includes handle grips of 1/8" x 1/2" coiled steel. All grate bars are welded on both sides. Finished with high temp, non-toxic black enamel paint.
- Pin anchors provide a fixed location.
- The ring is filled with aggregate (not included) to about 9" deep to provide the elevated fire surface. This fill also insulates the ground to reduce the chance of root fires in heavily wooded areas. Drain/draft holes are provided around the perimeter of the ring.
- **Optional:** FSW Series 300 sq. in. swivel grate (replaces flip-over grate). Meets ADA guidelines for operation and weight. *See Page 117.*
- **Optional:** Bolt on utility shelf Model S5. *See Page 124.*
- **Optional:** Heat shield, welded on. *See Page 124.*



Model FS-30/18/PA accessible campfire ring with standard flip-over grate.



Model FSW-30/18/PA Accessible Campfire Ring, 30" ID x 18" tall (nom.) with ADA compliant 300 sq. in. swivel cooking grate.

Model	Inside Diameter	Side Ht.	Anchor Systems	Cooking Area (Sq. In.)
FS-30/18/PA	30"	16-7/8"	PA only <i>See Page 125</i>	290 Flip Over
FS-30/24/PA		23-3/8"		
FSW-26/18/PA	24"	16-7/8"		300 Swivel
FSW-30/18/PA	30"	16-7/8"		
FSW-30/24/PA		23-3/8"		

ACCESSIBLE CAMPFIRE RING

- FSDW Series

- This accessible double wall campfire ring offers a **full-height outer ring as a heat barrier** for the inner ring. 1" dia. draft holes feed air into the space between the rings. Unit is equipped with a fire/log grate inside the ring (no aggregate fill required). Designed to accommodate a person in a wheelchair. Tip back anchor pins secure the unit in place.
- 1/8" thick steel outer ring with 1" formed flange; 3/16" thick steel inner ring; 17-3/8" tall fire barrier.
- 370 sq. inch single level cooking grate is permanently hinged to the outer ring. 380 sq. inch log grate hinged to the inner ring tips up to simplify ash clean out. The cooking and fire grates are fabricated using 5/8" dia. perimeter and handle bars with coiled steel bar grips, and 1/2" dia. grate bars. All grate bars are welded on both sides. Finished with high temp, non-toxic black enamel paint.
- **Optional:** Bolt on utility shelf Model S5. *See Page 124.*
- **Optional:** FSW Series Swivel Grate (replaces flip-over grate). Meets ADA guidelines for operation and weight. *See Page 117.*



Model FSDW-30/18/TB double walled campfire ring with optional swivel grate.



Model FSDW-30/18/TB double walled campfire ring.

Model	Inside, Outside Diameter	Side Ht.	Anchor Systems	Cooking Area (Sq. In.)	Fire Grate Area (Sq. In.)
FSDW-30/18/TB	26-3/8", 32"	17-3/8"	TB only <i>See Page 125</i>	370 Flip Over	380
FSDW-30/18/TB				300 Swivel	

STAINLESS STEEL CAMPFIRE RING - FSWS & FXS Series

- The **FSWS Series** Campfire Ring is rolled using 11 ga. (1/8" thick) **stainless steel** with a 1" roll formed top flange for additional strength and safety. Draft holes are provided for ventilation. The ring is not painted.
- The FSWS firering is available in five side heights. See chart below.
- Standard: 300 sq. inch single level **swivel cooking grate**, will move 180 degrees – from over the fire to completely out of the firering – for easy fire building and serving. The handle is never over the fire. Some installation required.
- The two tallest firerings with this swivel grate meet the ADA guidelines for reach and operability: one hand operation requiring less than 5 lbs. of force to move. The ring must be filled with aggregate (not included) about 9" deep to provide the elevated fire surface.
- **Swivel cooking grate** is a single welded component using 1/2-inch dia. black steel bars, mounted on a 2-3/8-inch OD steel tube allowing it to swivel 180 degrees. 5/8-inch dia. operator handle includes a 1/8-in. x 1/2-in. flat bar coiled grip. All grate bars are welded on both sides. Cooking grate components are finished with high temp, non-toxic black enamel paint.
- Standard: three black pin anchors (PA) to secure firering on site, into concrete footings (ring does not tip up).
- **Optional:** three black bolt on spade anchors to secure ring on site, buried in ground (ring does not tip up). *See Page 125.*
- **Optional:** Model S5 black bolt-on utility shelf. *See Page 124.*
- **Optional:** **FXS Series** stainless steel ring only, **no cooking grate.**



Model FSWS-30/7/PA stainless steel campfire ring with **Model S5 Shelf**.



Model FSWS-30/7/PA stainless steel campfire ring with **Model S5 Shelf**. Swivel grate is turned out of ring.



Model FXS-30/7/PA stainless steel campfire ring only, no grate.

Model	Inside/Outside Diameter (inches)	Side Height (inches)	Wheelchair Accessible Height	Anchor System	Swivel Grate Cooking Area (Sq. In.)	Optional: No cooking grate Order this Model #
FSWS-30/7/PA	30/32	7-1/4"	No	PA (Standard) AL (Optional) <i>See Page 125</i>	300	FXS-30/7/PA
FSWS-30/9/PA		8-7/8"				FXS-30/9/PA
FSWS-30/11/PA		11-1/4"				FXS-30/11/PA
FSWS-30/18/PA		16-3/4"	FXS-30/18/PA			
FSWS-30/24/PA		23-1/4"	Yes			FXS-30/24/PA

REMOVABLE COOKING GRATE - **Model I-RS**

- **Optional: Model I-RS** single level **removable cooking grate** can be used with the FXS Series stainless steel campfire rings.
- This **single-level tip-over cooking grate** provides 290 sq. inches of surface area. It can lay flat over the fire or be tipped over and out of the firering. The hinge/pivot bracket is bolted to the inside of the firering. When you don't need the cooking grate it can easily be removed from the hinge/pivot bracket.
- The cooking grate is a single welded component using a 5/8" dia. steel perimeter, 1/2-inch dia. steel grate bars and a 3/4" dia. handle bar. The handle bar also supports the cooking grate on the firering top flange. All grate bars are welded on both sides. The operator handle includes two 1/8"x 1/2" flat bar coiled grips.
- All grate kit components are finished with high temperature non-toxic black enamel paint.
- Some assembly is required to attach the cooking grate hinge/pivot brackets to the firering inside wall. Fasteners are included.



Model I-RS removable cooking grate.

FIRERING SPARK ARRESTOR - Model FRSA



- **Model FRSA** Firering Spark Arrestor can be laid on top of a wide variety of Pilot Rock campfire rings to reduce the sparks that can rise out of a campfire. See the table below.
- No assembly or installation is required.
- This spark arrestor screen is punched, laser cut and roll formed using 14 ga. steel; 1/4 in. dia. holes; steel bar reinforcement and handles; 1/8 in. x 1/2- in. coiled flat steel grips. Ships fully assembled.
- Firering Spark Arrestor can be lifted off the campfire ring to tend to the fire, or to replace the cooking grate over the fire for grilling. CAUTION: the unit will be hot.
- Model FRSA is designed to restrict sparks that might rise into the air. It will also reduce the size of the fire built in the firering by keeping the fire wood below the top of the firering. A smaller fire will also help in reducing the number of sparks.
- **Finish:** High temp non toxic black enamel paint on steel FRSA-1 and FRSA-2 models. Paint will burn off.
- **Optional:** Model CK-1 chain kit (40 inches of 1/8-in. galvanized steel chain with (2) S-hooks) can be used to tie Model FRSA to the campfire ring if desired.
- **Optional:** All stainless steel fabrication. These stainless steel designs are NOT painted. Use Model Numbers FRSAS-1 and FRSAS-2. See table below.



Model FRSA-1 firering spark arrestor, shown with model FX/30-9 firering



Model FRSA-2 firering spark arrestor, shown with model FA/30-9 firering

NOTE: These Firering Spark Arrestor screens may fit on other brands of campfire rings with similar dimensions. Compare the OD of your campfire ring to the ID of the Spark Arrestor (see table below). But we make no claim that Model FRSA-1 or FRSA-2 will fit on firerings from other manufacturers.

Model	Compatible With	Instructions	Dimensions OD = Outside Diameter ID = Inside Diameter
FRSA-1 <i>Painted Black</i>	FS-30, FSDW-30, FX-30, FXS-30	• Must tip FS cooking grate over/off of ring to install FRSA-1. Grate cannot be tipped over the ring w/FRSA-1 in place.	Screen ID: 34-3/4" Screen OD: 35" OD at handles: 43-3/8" Flange: 1" high
FRSAS-1 <i>Stainless Steel</i>			
FRSA-2 <i>Painted Black</i>	FA-30, FSW-30, FSW/SL-30, FSWS-30, FSWDW-30	• Must raise FA grate high enough to install FRSA-2 under grate. • Must turn FSW grate out of ring to install FRSA-2. FSW grate can then be turned back over the ring.	Screen ID: 34-3/4" Screen OD: 35" OD at handles: 43-3/8" OD to flat side: 28" Flange: 1" high
FRSAS-2 <i>Stainless Steel</i>			



In bear country?
Check out our **Bear Resistant Food Lockers** on pages 80 & 81.

DROP-IN GRATE - Model DIG-U4

Removable Cooking Grate for Your Firering or Fire Pit

- When you want to grill over your campfire just place **Model DIG-U4** "drop-in" grate across your steel firering or other fire pit. Lift it off when you are done cooking.
- **Model DIG-U4** drop in cooking grate is fabricated from a single piece of 10 ga. thick steel plate, and laser cut to form the shape and grate bars. Die-formed edge flanges add strength. It is finished with high temp, non-toxic black enamel paint. Ships fully assembled.
- Cooking area dimensions: 21-3/4" x 13-1/2". 294 sq. inches total.
- Overall dimensions: 37-1/2" long x 15-1/4" wide. Weight: 18 lbs.
- Use **Model DIG-U4** with steel rings or stone/concrete fire pits.
- **Model DIG-U4** will fit:
 Round Firerings and Fire Pits: 27" to 31" inside diameter.
 Square Fire Pits: 23" – 27" inside dimension.
- **Optional** Model DIG/S-U4 drop-in grate made using 11 ga. **stainless steel**. Not painted.



Model DIG-U4 Drop-in cooking grate.



Model DIG-U4 Drop-in cooking grate can be used on fire pits constructed of landscaping stones with or without a steel insert.



Model DIG/S-U4 Drop-in cooking grate on a Pilot Rock FXS-30 Series stainless steel campfire ring.

FOLDABLE COOKING GRATE - Model DIG-R35

- **Model DIG-R35** is a hinged, foldable Cooking Grate designed for use on backyard firepits. It can be used on brick and block firepits with or without a steel insert.
- The two sections of this cooking grate mate together with welded-on hinge pins. It folds in half for easy transport or storage.
- Unfold the cooking grate to its full diameter of 34-1/2" and place on top of your firepit. One side of the grate can be lifted up and over center. It will not fold all the way over so your food on the other half is not disturbed. The raised-over-center grate will stay in place so you have both hands free to tend to the fire on the open side. A lifting tool is included. USE CAUTION - THE GRATE WILL BE HOT.
- The DIG-R35 can be removed from your firepit when you are done grilling and you want to enjoy the fire only.
- Fabrication: All 10 ga. steel plate, precision laser cut. Finished with high temp, non-toxic black enamel paint. Season the grate before first use.
- Easy assembly. The two halves slip together at hinge points. No tools, no fasteners required.

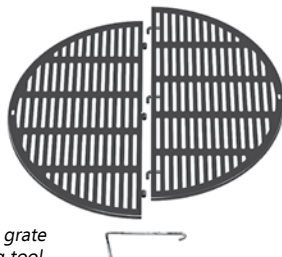

Model DIG-R35 foldable cooking grate includes two grate sections and lifting tool.



Model DIG-R35 Foldable Cooking Grate shown on a backyard firepit.

- Product dimensions:
Folded: 34-1/2" wide x 18" long x 1" thick
Unfolded: 34-1/2" wide x 35-1/4" long x 5/8" thick

CAMPFIRE RING COVERS - Model CF

- Can't wait for your campfire to burn itself out? Use a Snuffer Cover to cover the fire and restrict the air supply to the fire. Has it gotten too windy for an open fire? A Snuffer Cover will help to contain and choke your fire out. Just want to protect your campfire ring from the elements when not in use? A Snuffer Cover can help with that, too.
- These fire ring covers are designed to fit Pilot Rock FA-30, FS-30, FSW-30 and FX-30 Series campfire rings with a 30" ID and 32" OD at the top flange. See chart. They may also fit other brand firerings with similar dimensions.
- **Fabrication:** One piece, 16 ga. pre-galvanized steel, with 1/2" formed lip around outside edge, two handles.

Snuffer Cover Number	Fits Pilot Rock Campfire Ring Series	Cover Inside Diameter	Cover Weight
CFA-30	FA-30	34-3/4"	17 lbs.
CFS-30	FS-30		
CFSW-30	FSW-30, FSWS-30 & FSW/SL-30		
CFX-30	FX-30 (no grate) & FXS-30 (no grate)		

Snuffer Covers Can Help You Put Out the Campfire



Model CFA-30 Snuffer Cover on a Pilot Rock FA-30 Series campfire ring.



Model CFS-30 Snuffer Cover on a Pilot Rock FS-30 Series campfire ring.



Model CFSW-30 Snuffer Cover on a Pilot Rock FSW-30 Series campfire ring.

FIRERING LOCKOUT COVER - Model FLC/B-30

- **Model FLC/B-30** Firering Lockout Cover can be used to take a Pilot Rock campfire ring out of service.
- This steel cover slides onto the campfire ring and hooks under the formed flange around the top of the ring. One hook is padlocked on to prevent cover from being removed.
- Cover can be used to restrict the use of campground firerings when a burn ban is in place, or for any reason you want to prevent campfires in an area. It can be easily removed whenever it is safe for campers to burn again.
- Heavy 12 ga. steel plate fabrication, (2) welded on hooks and (1) padlocked-on hook, flange reinforced. A convenient carry handle is cut into the cover.
- Finished with high temp non-toxic black enamel paint.
- Model FLC/B-30 Firering Lockout Cover will fit most Pilot Rock campfire rings with a 30 inch inside diameter and a 32 inch outside diameter at the top flange. Refer to the table for more information.

Included:

- (1) padlock (*Model PL-1, all keyed alike*)
- (1) warning/information decal



Model FLC/B-30 Firering Lockout Cover installed over a Pilot Rock FA-30 Series campfire ring.



Model FLC/B-30 Firering Lockout Cover installed over a Pilot Rock FS-30 Series campfire ring.

Model FLC/B-30 Firering Lockout Cover Use and Limitations				
Compatible With:	My Campfire Ring Has A #S5 Bolt-on Shelf:	My Campfire Has A Welded-on Heat Shield:	My Campfire Ring Has A Bolted-on Heat Shield:	FLC/B-30 Lockout Cover will NOT fit on:
FA-30 FS-30 FSDW-30 FSW-30 FSWS-30 FSW/SL-30 FX-30 FXS-30	Model S5 shelf will conflict with the installation of this Cover. The shelf will need to be removed. Note: If the S5 shelf is mounted to the welded-on heat shield then this Cover will fit.	This Cover will fit on FA-30, FS-30, FSW-30, FSW/SL-30 and FX-30 firerings that include the WELDED-ON heat shield.	This Cover will NOT fit on any campfire ring with the Bolted-on heat shield. You would need to remove the heat shield to install the Cover.	FSDW-30/18 swivel grate, double wall firering.

Note: Currently we do not have Lockout Covers for Model L-32, Model M-32, smaller (26") diameter or larger (48" or 56") diameter campfire rings.

CLEAN OUT SHOVEL - *Model FCS-1*



- **Model FCS-1** is a specially designed shovel to clean out campfire rings. You can scoop out ashes and coals without disturbing the aggregate or ground surface beneath. The front edge of the shovel is cut to a radius to match the inside curvature of most 30-inch (nom.) inside diameter firerings. The back edge is flat so you can also clean out square corners and flat surfaces found in some firerings. The handle is hinged so you can use either edge of the shovel. It will also come in handy for cleaning out larger 48" and 56" diameter firerings.
- The angle of the shovel and handle make it comfortable to use. The shovel is formed from 14 ga. steel. The 1/2" dia. steel bar handle includes our coiled steel spring grip. Finish: High temp black enamel paint. Some assembly required.

Model FCS-1 Fire ring Cleanout Shovel scoops up ashes and coals and debris from inside the ring without disturbing the base surface you want to keep under the campfire.



Model FCS-1 Firing Cleanout Shovel has one curved edge cut to match the inside radius of most 30" ID campfire rings, plus a straight edge useful for square corners and flat walls found in some ring designs.

UTILITY SHELF - *Bolts onto both Firerings and Heat Shields*



Model S5 utility shelf provides a handy place for condiments, utensils, or pots and pans. The shelf is available on most firering models and heat shields and will not interfere with grate adjustment. Constructed from 3/16" x 7-1/8" x 9-5/8" plate steel, the shelf is finished in high temperature black enamel paint. Fasteners are included.

Optional Shelf Model S5 as shown on Model FA-30/18 Firing



Optional Shelf Model S5 as shown on Heat Shield

HEAT SHIELDS - *for Added Protection from Hot Surfaces*



- This optional **welded-on** Heat Shield is available on select Pilot Rock campfire rings (see chart below). This welded on Heat Shield can be added to new Pilot Rock firerings to give protection from hot surfaces around the outside of the ring. The 10 ga. x 8-inch high Shield provides a 7/8-inch air gap around the area of the tall firerings exposed to heat (the lower portion of these tall rings is filled with aggregate). Any debris that gets between the ring and the Shield will fall out the open bottom.
- To order a welded-on Heat Shield for your new Pilot Rock campfire ring add "/H" at the end of the model number (e.g. FS-30/18/PA/H).
- **Optional:** Bolt on utility shelf Model S5. See above.

Note on accessibility: Current ADA guidelines define the space around campfire rings to provide 48" of clearance. Exceptions can reduce this clearance to 36". In these tighter clearances a Heat Shield could provide an added level of safety.

Heat Shield Fits Firing Models	Outside Diameter (inches)
M-32/17/PA	32-11/16
FA-30/11, FA-30/18,	32-11/16
FS-30/18/PA, FS-30/24/PA, FS-30/11	32-11/16
FSW-26/18/PA	26-11/16
FX-30, FSW-30, FSW/SL-30 11", 18" and 24" tall	32-11/16

FIRERING ANCHORING SYSTEMS

Firerings may be anchored in several different ways. Not all anchoring systems are available on all firerings. Check the description for each firering to determine which anchoring options are available.



◀ TIP-BACK ANCHORS (TB)

Tip-back anchors for firerings, as specified by /TB in the model numbers, permanently locate firerings yet allow them to tip back for easy clean-out. The anchors are 1/2" dia. steel rod designed to be installed through welded-on tip-back brackets at the rear of the firering and embedded 15" into a concrete footing.

ANGLE SPADE ANCHORS (AL) ▶

Angle spade anchors for firerings, as specified by /AL in the model numbers, secure firerings on site. The firering cannot be tipped up. The anchors are constructed of heavy 3/16" x 1-3/4" x 1-3/4" A-36 steel angle with a welded-on spade of 1/8" steel. Anchors are attached at equidistant points around the firering and installed directly into the ground without the need for concrete.



◀ PIN ANCHORS (PA)

Pin anchors for firerings, as specified by /PA in the model numbers, permanently locate firerings. The anchors are "U" shaped 1/2" dia. steel rods and are embedded 15" into concrete footings. The anchors are installed through the draft/drain holes located around the lower perimeter of each firering. The firering cannot be tipped up.



TIP-BACK ANGLE SPADE ANCHORS (TA) ▶

Tip-back angle spade anchors for firerings, as specified by /TA in the model numbers, secure firerings on site without concrete footings and allow the firering to tip back. Two angle spade anchors are inserted into the ground. The 1/2" dia. steel rod hinge pin is inserted through holes in each anchor and through the holes in the tip-back brackets welded to the firering. The rod is bent to secure the firering to the anchors.



◀ TIP BACK-BOLT DOWN ANCHOR BRACKET (TB-BD)

Tip Back-Bolt Down bracket for firerings as specified by /TB-BD at end of model number. This bracket will anchor your FA-30, FS-30, FSW-30, FSW/SL-30, FX-30 and L-32 firering with tip-back tabs to an existing concrete surface. The firering will be able to tip up. Fabricated with 7 ga. (3/16") thick steel, with (3) 5/8-in. dia. holes (for 1/2 in. dia. anchor bolts). The TB-BD bracket includes fasteners to attach it to the firering tabs. **It does not include the (3) surface anchor bolts.**

Note: We do not recommend installation on top of concrete. But if you choose to install a firering on concrete the TB-BD anchor will secure the firering onto your concrete base.

ANCHOR KITS	PRODUCTS					
	BENCHES	BIKE RACKS & PARKING	TABLES	WASTE & RECYCLING	AMENITIES	GRILLS & FIRERINGS
BR-4HSA (4) 3/8" x 1-7/8" Bolt Sleeve (See #1)	CLB, GBA-4, GBA-6, GBA3, GBA4 (2 Kits per Bench)	BR-6DS, BR-6SS, BR-12DS, BS, BSM		SS/P-1 ^{‡4}		HCB-1
ANC1-4 (4) 1/2" x 3" Screw Anchors (See #1)	APB/P (1 Kit per leg), B30, B32, OWB/P, OWRB/P, PWB, PWRB	BR20, BR30, BR31 BR102, BR104, BR106	APT/P (1 Kit per leg)	M3, M5, M7, M11, CN-TR/P-52 ^{‡4}	TB-1, APTX/P, ULT/P-1, ULT/P-2, ULT/P-4 ULT/P-3 (2 Kits per Table)	B3, B7, B8, B17, B18, RL-35, RL-36
ANC1-4SS (4) 1/2" x 3" Stainless Steel Screw Anchors (See #1)						B17S, B19S
ANC1-6 (6) 1/2" x 3" Screw Anchors (See #1)	B30C, B32C, PWB3, PWRB3					
ANC2-4 (4) 3/8" x 5" Screw Anchors (See #1)	6' & 8' B302; 21' B304 (2 Kits per 21' Bench)	BR205SS, BR210SS, BR210DS, HRP-6	T720	CN-R/SS2-36D, CN-Q/SS4-36D, CN-R/SP3-36D		
ANC2-6 (6) 3/8" x 5" Screw Anchors (See #1)	12' & 15' B303	BR220DS, HRP-8				
ANC3-4 (4) 3/8" x 3" Screw Anchors (See #1)	PAB, SAB/P, PCB, PCXB, B40, B42, B60, B62, B76, B78, B80, B82, B100, B102, B120, B122, B130, B132, 4', 5', 6' BC3000, BC4000, B400, B410, B412	HRP, SRP-3, SRP-5, SRP-7, SRP-9, SRP-11, BR310DS	6' & 8' T600, 6' & 8' T700, TQ700, 6' & 8' T702 (need three kits), TQ704 (need five kits), FCT-4	CN-R/SS2-36 ^{‡4} , CN-R/SP2-32, CN-R/SS3-36, CN-AMR, CN-AMQ, CN-R/R, CN-R/D, CN-Q/D-32, CN-Q-36	6' & 8' XTX, P-22, P-23	GS-5
ANC3-6 (6) 3/8" x 3" Screw Anchors (See #1)	PAB3, SAB3/P, PCB3, PCXB3, B40C, B42C, B110, 8' BC3002, 8' BC4002	ORP, SRP-13, BR320DS	10' T600		10' XTX	
ANC4-4 (4) 1/2" x 3-3/4" Wedge Anchors (See #1)	B90, B94					
ANC5-4 (4) 1/2" x 5" Screw Anchors (See #1)			PT/P, PQT/P, T400 TPT/P, CST/P (1 kit per post)	CN-VDT/P-32 ^{‡4} , BPRT1-36 ^{‡4}	TB/P-2, BPFL ^{‡4} , MST/P-1R (need three kits)	
ANC5-6 (6) 1/2" x 5" Screw Anchors (See #1)				BPRT2-72 ^{‡4} , BPRT3-108 ^{‡4}		
ANC6-4 (4) 1/4" x 1-3/4" Screw Anchors (See #1)	Used with all ANG-3 and ANG-5 Strap Anchors on Page 127		‡ NOTES: 1. All BR-4HSA, ANC1, ANC2, ANC3, ANC4, ANC5, and ANC6 Anchor Kits are for concrete surface installations only. 2. ANC11 and ANC12 Anchor Kits are for asphalt or ground surface installations only. 3. Models Q3-2460, P-1000, and L-1500 Grills include (4) 1/2" x 6" J-bolts for embedding into concrete footings. (Install when concrete is poured.) 4. Model SS/P-1, Models CN-TR/P-52, trash receptacles, and Model CN-VDT/P-32 trash can cover, and all Model BPRT bear resistant receptacles and Model BPFL bear resistant food lockers each include a set of anchor bolts. Order replacement anchor kits above.			
ANC11-3 (3) 3/4" x 17-3/4" Anchor Stakes (See #2)		CSL-6, CSL-8 SB-6, SB-8				
ANC12-3 (3) 3/4" x 24" Anchor Stakes (See #2)		CSL-6, CSL-8 SB-6, SB-8				

Anchor Options for Tables and Benches

STRAP ANCHOR:

One pair, secure tables with steel tube frames. 1/4" dia. holes. Anchor bolts not included.

Model ANG-3: fits 2-3/8" OD frames – XT, XTH, WXT, WXTH, BTXG and T200 tables.

Model ANG-5: fits 1-5/8" OD frames – UT, UTH, UTK, BTUG, SQT, SQTK, T104K and T100 tables.

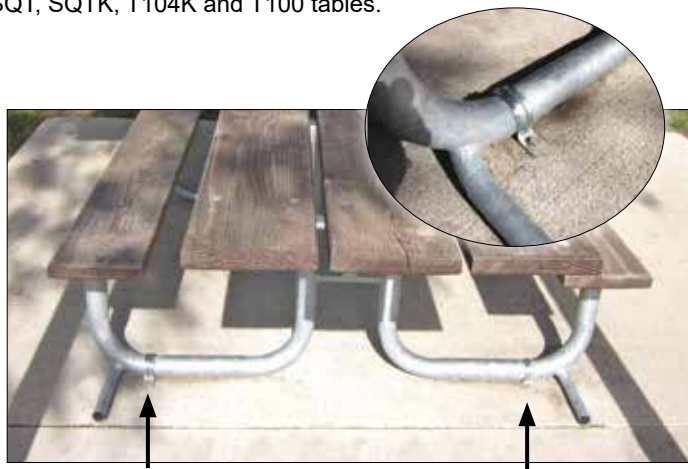

Note: We recommend using 2 pairs for most tables.

ANGLE ANCHOR:

One pair of formed steel angles. Use with AT, AFT, and RT tables and RB benches. Angles attach to frames with included screws. Then secure to surface with 3/8" dia. bolts appropriate for mounting surface (not included). Use one pair per frame.

Model ANG-2.



Note: We recommend using 2 pairs for most tables and benches.

DRIVE-IN GROUND ANCHOR:

Driven deep into ground with heavy hammer and optional drive stake. Attaches to table or bench with wire rope and/or heavy chain. Optional **Model PL-1** padlock secures wire rope to bench/table.



ANCHORS:

Model 68-DBII:

- 1700 lb. capacity,
- 1/8" x 5 ft. galvanized wire rope.

Model 88-DB-11:

- 7000 lb. capacity,
- 1/4" x 6 ft. galvanized wire rope.

DRIVE RODS:

Model DS-68:

- 1/2" x 3 ft. steel rod with large striking head.
- Use with #68-DBII anchor.

Model DS-1:

- 3/4" x 4 ft. steel rod tapered to 1/2", heavy-duty frequent use.
- Use with #68-DBII anchor.

Model DS-2:

- 3/4" x 4 ft. steel rod.
- For use with #88-DB-11 anchor.

AUGER ANCHOR:

Screw-type auger; 1/2" diameter steel shaft with 3-1/2" dia. auger. Screw into ground until only "eye" is exposed. Includes 30" long heavy link chain secured to stake with cold shut. Optional **Model PL-1** padlock can secure chain to table. **Model AGS-1.**

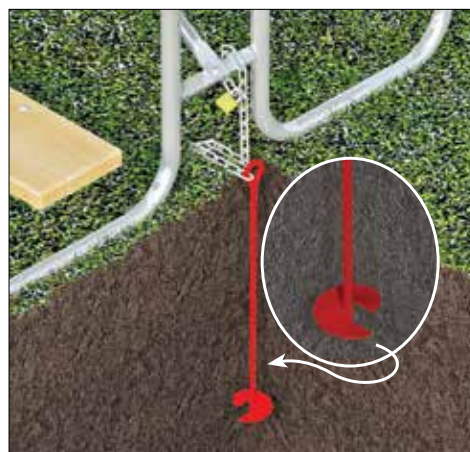

Shop Online at pilotrock.com

Join our e-newsletter for the latest information and promotions . . .
go to pilotrock.com

ORDERING INFORMATION

Write Purchase Orders and Payments to: R. J. Thomas Mfg. Co., Inc. R. J. Thomas Mfg. Co., Inc. is a small business.

GSA Contracts may be available for federal accounts. Contact Customer Service for Contract information.

PRICE: All prices are F.O.B. Cherokee, Iowa. Prices are subject to change without notice. Quantity discounts and freight allowances may be available.

TERMS: Net due 30 days from date of invoice to those with established credit. First time orders and others: prepayment in full before shipment. Finance charges after 30 days. Payment by credit card is accepted using:



FREIGHT: Prepaid and added to the invoice, or third-party billed. Weights listed are approximate and do not include packaging. Shipment will be made by the quickest, most economical and practical means possible. Call for freight estimate. Most products are shipped unassembled to minimize shipping costs. Detailed assembly instructions are included with fasteners. Shipments may be subject to additional charges such as: residential delivery, lift gate, oversize shipment, re-consignment, metro delivery and other fees.

LEAD TIMES: Order as early as possible. Our usual lead times run 4 weeks from order date to ship date. Busy season lead times can reach 6 to 8 weeks. When you order early, we can better arrange delivery to meet your needs.

SPECIFICATIONS: Specifications were in effect when printing this

catalog. Since product improvements are always being made, we reserve the right to change designs, specifications and discontinue products without notice. Where changes have been made, revised products will be shipped unless specific arrangements have been made to the contrary.

ADDITIONAL INFORMATION: Contact us if you require additional information on product specifications, assembly, or installation. Spec Bulletins are available on our web site.

MODIFICATIONS: If a desired combination of features, materials, options, or accessories is not covered in this catalog, contact us and we will advise as to availability and price. We do have custom design/fabrication capabilities for volume projects.

RETURN POLICY: No returns are accepted without prior approval. Call Customer Service for a Return Authorization (RA) number. Requests must be made within (30) days of receipt of product. No returns will be accepted after (30) days. Products must be returned in original packaging, must not be used or damaged, and must be in resalable condition. Returns may be subject to a restocking charge. Return freight must be prepaid.

ORDER CANCELLATION: Orders for standard products may be cancelled prior to shipment. Conditions will vary. Orders cancelled after shipment are subject to return freight charges and restocking fees. Any product that includes custom features or modifications (from our standard product designs) cannot be returned for refund or credit. Any order that includes custom signage (in any form) cannot be cancelled after we receive your final design approval. Products that include custom signage cannot be returned for refund or credit. All sales are final for customized products.

SHIPPING INFORMATION

FREIGHT SHIPPING METHOD: Most of the time we will ship by truck freight (see below), but some items can ship by UPS or FedEx. We will tell you how your products will ship in our Quote Response and Order Acknowledgment.

NOTE: freight quotes are valid for (14) days from the quotation date. After (14) days it will be necessary to confirm/quote the freight cost.

TRUCK FREIGHT: Unless other method is specified, all Freight Estimates are calculated using commercial truck freight shipping to a BUSINESS OR COMMERCIAL ADDRESS able to receive and unload packaged or palletized freight. Someone must be available to inspect and sign for the freight. The truck driver is not required to unload the freight, so the ship to address must have the personnel or machines to unload the freight.

ADDITIONAL FREIGHT SERVICES: If you require additional freight services, such as pre-notification, lift gate or inside delivery, there may be EXTRA CHARGES if these services are available at your destination. You must contact our Customer Service Dept. for information on the costs and availability of these additional services PRIOR TO PLACING YOUR ORDER.

WHEN YOUR FREIGHT ARRIVES: Before signing the Carrier Freight Bill:

- #1) Make a close visual inspection of all pallets, boxes, cartons or crates for any visible damage.
- #2) Note any damage or shortage on the face of the Receiving Slip before you sign - BE SPECIFIC. Take photos if possible.
- #3) Retain one copy of the Receiving Slip and notify our office immediately by calling 1-800-762-5002.

FAILURE TO FOLLOW THESE STEPS WILL RELEASE THE CARRIER FROM ANY RESPONSIBILITY FOR LOSS OR DAMAGE.

If concealed damage or any shortages are discovered after unpacking, contact our Customer Service Dept. immediately at 1-800-762-5002. Take photos of the packaging and damaged items. You have (10) business days to report any damage or missing items to R.J. Thomas Mfg. Co.

ASSEMBLY: Picnic tables, benches, some trash receptacle holders and some bicycle racks are shipped unassembled, with assembly required. Assembly hardware is included, and holes are pre drilled. Grills and campfire rings are shipped mostly assembled, but some minor assembly and installation are required. Prices DO NOT include assembly or installation.

THANK YOU for your order: If you have any additional questions, please contact Customer Service at 800-762-5002 (or 712-225-5115) or e-mail to customerservice@rjthomas.com. Thank you for your interest in our Pilot Rock products.

PRODUCT WARRANTY

TERM	PRODUCT	OTHER INFORMATION	REQUIREMENTS	EXCLUSIONS
LIFETIME	Picnic Table Frames: UT, UTH, XT, XTH, WXT, WXTH	Original Owner Only	All products must: 1) be assembled and installed according to manufacturer's specifications and instructions. 2) be properly maintained 3) not have been altered by the addition or deletion of parts, or modified in any other manner.	Vandalism. Damage caused by incorrect assembly, installation, application (use), or negligence. Natural or manmade disasters. Cosmetic changes due to weathering - including paint fading, discoloration of wood, or color fading or spotting of coated steel and recycled plastic products caused by exposure to natural elements or chemicals. Scratches, dents, or marring caused by normal use and public exposure. Seasons checks, twisting, or splintering of wood caused by climatic differences or lack of proper maintenance. Loss or damage in transit while product is responsibility of carrier. High heat paint subject to overly built fires. Steel warpage caused by fires of excessive size or duration Premature rust-through of grill boxes due to improper cleaning or maintenance, and fire rings buried in the ground. Premature rusting or discoloring caused by corrosive environment or while in ocean transit. Damage caused by animals or wildlife.
ONE YEAR	Powder Coat, Enamel, & High Heat Paints; Lumber; Trash & Recycling Lids & Liners; Plaques; Decals; Resin Fill; Umbrellas; Pet Waste Stations; FSW Swivel Grate	No Warranty on Lumber shipped outside the United States. Water Repellant recommended on Lumber.		
FIVE YEARS	Thermo-Plastic Coating	Limited and Prorated Warranty on coating material against defects when subjected to normal use and proper maintenance.		
	Picnic Table Frames (those not included in Lifetime Warranty), Park Bench Frames, Steel and Aluminum Bench and Table seat/top Structures, Recycled Plastic Components, Bike Racks, TRH and TRQ Frames, Steel Trash Receptacle and Planter Structures, Pedestal Mounts, Tissue Holders, all Grills, Hot Coal Bin, Utility Tables, Campfire Rings, Lantern Holders, Food Lockers, Kolor Cans.	Recycled Plastic warranty applies only to components that have been cut, drilled, or routed by the manufacturer. This warranty does NOT cover plastic purchased in raw stock form by customer and cut, drilled, or routed by customer for custom application. Recycled Plastic and Thermo-Plastic coated components include a UV stabilizer to retard effects of natural exposure. We cannot warrant "fading" or surface "contamination" due to extreme variations in levels of exposure and in the definition of "fading".		
FIFTY YEARS	Recycled Plastic	Material decomposition only.		

Warranty claims must be filed within the warranty period and must include a copy of the invoice or the purchase order.

Except as specifically stated herein, all warranties (expressed or implied) are hereby excluded. This Warranty excludes any liability, consequential damages, or related costs.



California Customers

Please be advised . .

This notice is pursuant to California Health and Safety Code section 25249.5 et seq. ("Prop 65") and one of its enabling regulations at 27 CCR § 25600.2(b) (effective 30 August 2018). California law requires any company to declare if their products contain certain substances, as so listed on <https://oehha.ca.gov/proposition-65/proposition-65-list> and those products are sold in California.

PRODUCTS USING STEEL WARNING:

Some metal items may contain components or synthetics known to the State of California to cause cancer, birth defects or reproductive harm. These elements include but are not limited to Chromium, Cobalt, Lead and Nickel.

PRODUCTS USING LUMBER WARNING: (Benches, Picnic Tables, Trash Receptacles)

Drilling, sawing, sanding or machining wood products can expose you to wood dust, a substance known to the state of California to cause cancer. Avoid inhaling wood dust or use a dust mask or other safeguards for personal protection.

GRILL & CAMPFIRE RING WARNING:

This product can expose you to Carbon Monoxide, which is a combustion by-product known to the State of California to cause birth defects or other reproductive harm. For more information go to www.P65Warnings.ca.gov. Carbon monoxide can replace oxygen in the bloodstream. Reduced levels of oxygen during pregnancy can affect development of the baby's brain. Carbon monoxide is a colorless, odorless and poisonous gas that is formed during the combustion of various fuels in park grills and campfire rings – including propane, wood and charcoal. The exposure is not from the grill or the campfire ring, but from the fuel used. Exposure occurs by breathing air that contains carbon monoxide.

To reduce exposure to carbon monoxide: Ensure that grills and campfire rings are installed correctly outdoors and maintained properly. Never use charcoal or propane grills or barbecues, or campfire rings indoors.

For any questions concerning Proposition 65 refer to:

<https://oehha.ca.gov/proposition-65/law/proposition-65-law-and-regulations>





R.J. Thomas Mfg. Co. Inc. has the facilities and capacity to take on your job or idea and turn it into a finished product no matter what step of the process you are in - whether it be design, cutting, fabricating, welding, or finishing.

www.RJThomasFabrication.com

PRODUCT DESIGN

Our engineering and design departments use the latest versions of AutoCad and Inventor drafting software. We are regularly taking classes to keep up to date and take advantage of new design software advancements.

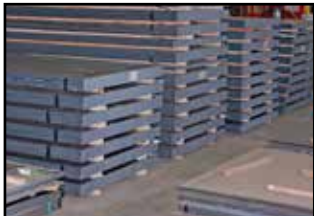

MATERIAL SOURCING

Through decades of manufacturing our OEM products we have been able to leverage our material volume to negotiate excellent pricing from our suppliers on a large variety of materials. We are able to use this pricing to offer reduced costs to our customers.

FIBER LASER CUTTING

Our 10KW Bystronic laser has the capability to process 5'x10' sheets with accuracy to .002" in thin sheet metal. Additional tolerances within .01" in thicknesses up to 1/2" mild steel, or .015" tolerance on thicknesses between 1/2" & 1-1/8".

Our 3KW Trumpf Laser/Punch Combo machine has similar capabilities to our Bystronic laser, but features the abilities of a punching machine as well. Both machines are fully automated to easily process large runs with cost savings to our customers.

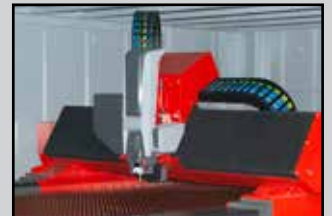

TUBE LASER CUTTING

The LT7 Lasertube is designed with 3kW fiber laser for cutting up to 6 in. round, square and rectangular sections. The unit comes with active scan, tilt, focus, marking, speed and piercing options.

With Active Tilt the orientation movement of the cutting head allows you to achieve unimaginable productivity, especially when cutting thin-wall materials.

DEBURRING

Our deburring machine has the capability to debur and edge round both the top and bottom of your part at the same time. This is a huge advantage for anything with a finish coating! Paints and powders do not like sharp edges, and even your unburred edges still have a straight 90 degree edge. Edge rounding is essential for any finished product on top and bottom.

Our Fladder deburring machine is able to deoxidize thicker material.



CNC SHEET METAL FORMING

We have both automated and manual CNC Press brakes that can handle large and small parts.

Our Bystronic Press Brake includes a Laser Angle Measurement System (LAMS) that measures the bend thousands of times per second to adjust for different tensile strengths across the sheet.

MANUAL AND ROBOTIC WELDING

We have several Pulse Mig Welders and an experienced welding staff to operate them.

We have over a dozen robotic welders for large run welding jobs.



CNC ROD FORMING

Our CNC rod former will take rod directly from the coil, then straighten, form, and cut all in one step. Large runs of even complex formed rods can be done with minimal labor costs.

Available in 1/4", 3/8", 1/2", and 5/8" thicknesses.

POWDER COATING

Our powder coat system is a multi-step process that includes: detailed chemical cleaning, a high pressure/high temperature bath, rinse, seal rinse, high temperature dry time, electrostatic application of lead-free TGIC polyester powder coat paint, and final chemical bonding to the metal substrate in a 430 degree oven.

You can choose from any of our OEM colors with custom colors available on larger runs.



THERMOPLASTIC COATING

We run a unique dip style thermoplastic coating process that allows us to achieve 30-40 mil thicknesses (*vs. the standard 3-4*). This makes for an extremely durable finish. Thicker or thinner coatings available upon request.

The UV-stable thermoplastic coating is applied in a multi-step process, including: cleaning, heating, dipping in a fluidized bed of colored polyethylene powder, and baking to cure the application. This complete process is designed and formulated to create superior adhesion.

We are regularly upgrading and expanding both our production space and our production capacity. If you have a need that is not listed here, don't hesitate to ask! Our sixty-plus years of design, fabrication and finishing experience can help reduce your costs and shorten your lead times.

Contact us today for a free estimate on your design, fabrication or coating project.

RJ Thomas Mfg. Co, Inc.
PO Box 946
Cherokee, IA 51012-0946
www.PilotRock.com

PSRT STD
U.S. POSTAGE
PAID
MAILED FROM
ZIP CODE 51012
PERMIT NO. 151



*Scan the QR Code to
visit our website now!*



© 2022 RJ Thomas Mfg. Co.
maintains all copyrights to
information, images and photos
used in this catalog.

Printed in USA

PILOT ROCK® is a registered trademark
of RJThomas Mfg.Co., Inc.

